

34 459 979















Fits: IMO, LULU, TARA, LISSÉ, VAIA, META

- shower with fixed riser projection 453mm
- overhead shower: rain flow
- rain shower with anti-scale system
- rain shower Ø 220 mm
- max. rainshower flow 6.8 l/min
- rotary diverter with volume control and shut-off function
- height of fittings up to top edge of elbow 1150mm
- slide-on rosettes Ø 70 mm
- height of fittings up to rain shower (bottom edge) 1009mm
- gauge 150 mm - 13 mm
- metal shower hose 1750mm with integrated anti-twist protection
- 1/2" connection
- slide bar
- Pipe diameter 23.5 mm
- quick clearing
- This product reduces water consumption by % (compared to requirements of EPAct '92)
- This product can contribute to Water Use Reduction in LEED® Green Building Rating

Intrinsic protection against back flow.

NOTE: Hand shower sold separately. Please see hand shower options under the miscellaneous articles section of each series.

	Brushed Chrome	34 459 979-93 0010
	Chrome	34 459 979-00 0010
	Brushed Platinum	34 459 979-06 0010
	Platinum	34 459 979-08 0010
	Dark Chrome	34 459 979-19 0010
	Light Gold	34 459 979-26 0010
	Brushed Light Gold	34 459 979-27 0010
	Brushed Durabronze (23kt Gold)	34 459 979-28 0010
	Matte Black	34 459 979-33 0010
	Brushed Bronze	34 459 979-42 0010
	Brushed Champagne (22kt Gold)	34 459 979-46 0010
	Champagne (22kt Gold)	34 459 979-47 0010
	Brushed Dark Platinum	34 459 979-99 0010

34 459 979

mm [inches]
1:10

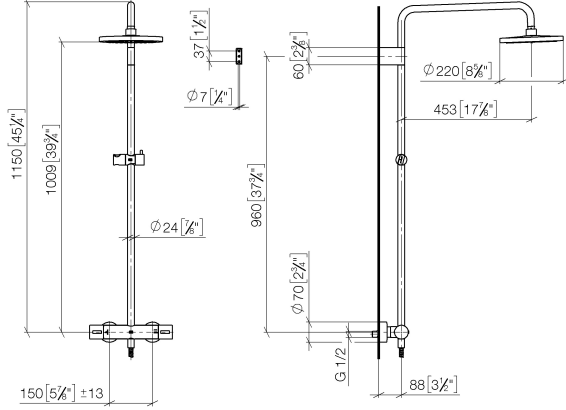

Flow rate chart

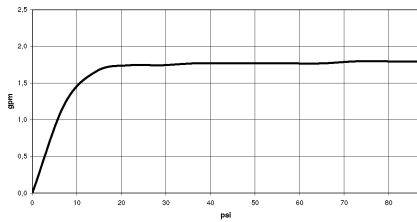

Codes & Standards

ASME
A112.18.1/CSA
B125.1

California Energy
Commission
(CEC)

34 459 979

Product version from 7/1/2023

Parts for other finishes can be found here: [Chrome](#)

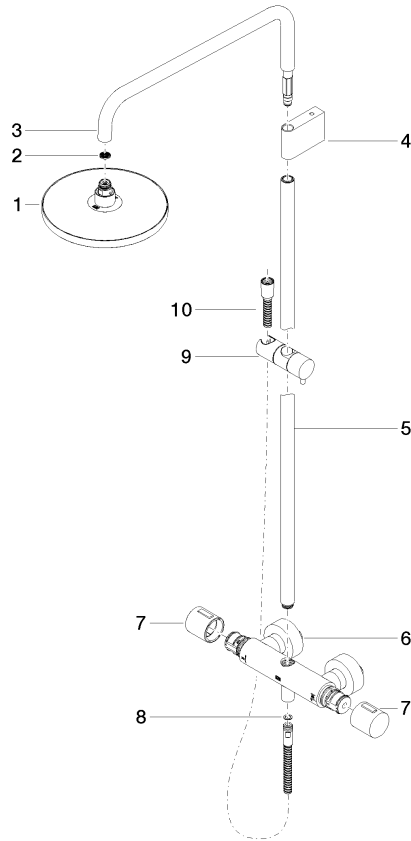



Showerpipe with shower thermostat without hand shower - Brushed Chrome

IMO

34 459 979

Spare parts list

Product version from 7/1/2023

No.	Item Number	Name	Quantity used	Delivery time
	04 12 05 092 10-93	shower	11	20