







SERIES-VARIOUS AQUAHALO Concealed ceiling installation box - Matte Black

35 750 970



- concealed rough parts
- Rain panel with 3 different flow modes
- AQUACIRCLE RAIN: Circular rain curtain, max. flow rate 6.8 l/min (at 3 bar)
- TEMPEST RAIN: Natural rain, max. flow rate 6.8 l/min (at 3 bar)
- DIAMOND RAIN: Ring of rain, max. flow rate 6.8 l/min (at 3 bar)
- Ceiling installation enclosure 605 x 605 x 95 mm
- Weight: 10 kg
- Supply pipe 7 m
- Input 100-240V AC 50-60Hz
- Output 12V DC SELV / Class II
- min. recess depth 110 mm
- max. recess depth 150 mm
- Provide DIN VDE 0100, Part 701 compliant safety zone 2
- Not suitable for use in a steam room.

includes light bulbs with a Class G energy efficiency

	Matte Black	35 750 970-33 0010
	Chrome	35 750 970-00 0010
	Brushed Platinum	35 750 970-06 0010
	Brushed Champagne (22kt Gold)	35 750 970-46 0010
	Champagne (22kt Gold)	35 750 970-47 0010



SERIES-VARIOUS AQUAHALO Concealed ceiling installation box - Matte Black

35 750 970

mm [inches] 1 : 10

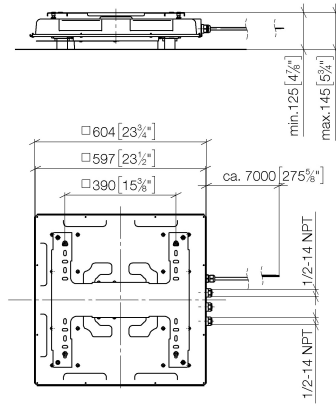



SERIES-VARIOUS AQUAHALO Concealed ceiling installation box - Matte Black

35 750 970

Product version from 4/1/2024

Parts for other finishes can be found here: Chrome

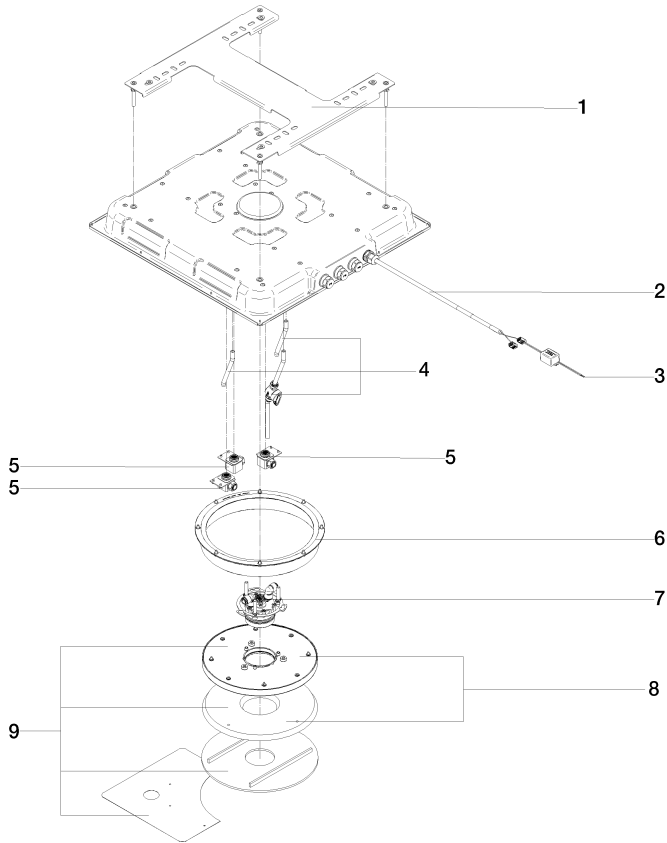



SERIES-VARIOUS AQUAHALO Concealed ceiling installation box - Matte
Black

35 750 970

Spare parts list

Product version from 4/1/2024

No.	Item Number	Name	Quantity used	Delivery time
	90 17 20 287 02 90	flange	11	2