





**CL.1 Concealed two-way diverter - Brushed Platinum**

CL.1

36 200 705



- rotary diverter
- rosette 60 x 60 mm
- with shut-off function

	Brushed Platinum	36 200 705-06 0010
	Chrome	36 200 705-00 0010
	Dark Chrome	36 200 705-19 0010
	Brushed Champagne (22kt Gold)	36 200 705-46 0010
	Champagne (22kt Gold)	36 200 705-47 0010
	Brushed Dark Platinum	36 200 705-99 0010

**Required miscellaneous**



- Concealed two-way diverter -** 35 202 970-90  
 •max. recess depth 160 mm 0010  
 •min. recess depth 115 mm

36 200 705

mm [inches]

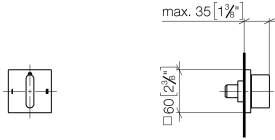

### Flow rate chart



### Codes & Standards

California Energy  
Commission  
(CEC)



## CL.1 Concealed two-way diverter - Brushed Platinum

---

CL.1

36 200 705

### Certificates

---

IAPMO\_4976 (7).

36 200 705

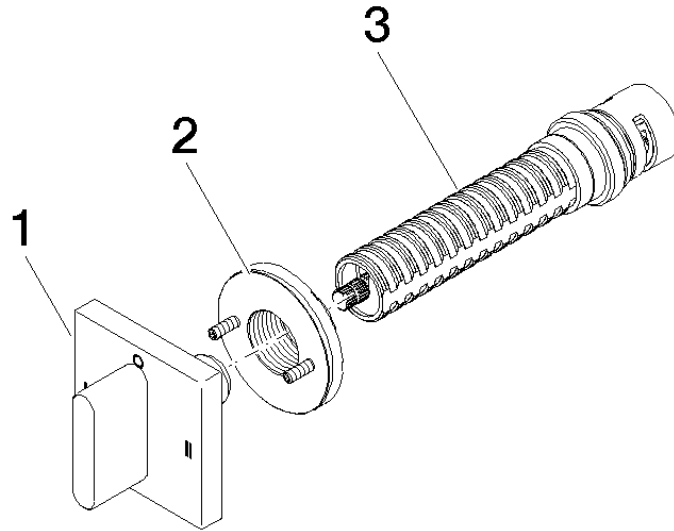

### Spare parts list

No.	Item Number	Name	Quantity used	Delivery time
1	90 20 70 051 09-06	handle	1	10
2	90 21 02 181 00 90	disc	1	2
3	90 90 03 306 10 90	diverter	1	2