

**Concealed three-way diverter - Brushed Champagne (22kt Gold)**











CL.1

36 210 740



- rotary diverter
- without rosette
- handle Ø 60mm
- with shut-off function

Fits: CL.1, META, CYO

	Brushed Champagne (22kt Gold)	36 210 740-46 0010
	Chrome	36 210 740-00 0010
	Brushed Platinum	36 210 740-06 0010
	Dark Chrome	36 210 740-19 0010
	Light Gold	36 210 740-26 0010
	Brushed Light Gold	36 210 740-27 0010
	Brushed Durabrass (23kt Gold)	36 210 740-28 0010
	Matte Black	36 210 740-33 0010
	Brushed Bronze	36 210 740-42 0010
	Champagne (22kt Gold)	36 210 740-47 0010
	Brushed Dark Platinum	36 210 740-99 0010

36 210 740

mm [inches]

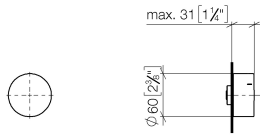

### Flow rate chart



### Codes & Standards

California Energy  
Commission  
(CEC)

36 210 740

Parts for other finishes can be found here: [Chrome](#)

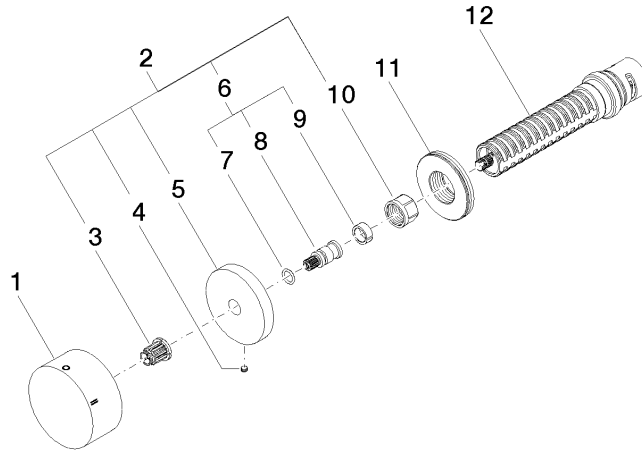

### Spare parts list

No.	Item Number	Name	Quantity used	Delivery time
1	09 20 74 043-46	handle	1	60
2	04 27 74 004 00-46	rosette	1	60
3	90 12 12 002 00 90	fixing cap	1	2
4	09 31 11 055 90	pin	1	2
5	09 27 74 004-46	rosette	1	60
6	04 29 06 020 00-00	spindle	1	10
7	90 14 10 060 00 90	seal	1	2
8	09 29 06 020-46	spindle	1	-
Spare part can no longer be ordered, please order the replacement item				
9	90 14 15 020 03 90	ring	1	2
10	90 23 30 023 00 90	nut	1	2
11	09 30 01 107 90	sleeve	1	2
12	90 90 03 305 10 90	diverter	1	2