

**WATER FAN horizontal Concealed body spray - Chrome**













IMO

36 512 979



- forceful flat water jet
- horizontal water jet
- cover plate 240 x 60 mm
- water jet adjustable
- 1/2" connection
- max. flow 6.8 l/min
- This product reduces water consumption by % (compared to requirements of EPAAct '92)
- This product can contribute to Water Use Reduction in LEED® Green Building Rating
- This product can help a building meet the requirements of Green Building Rating Systems, e.g. LEED®, BREEAM®, DGNB

Fits: IMO, LULU, MADISON, MEM, TARA, CL.1, LISSÉ, VAIA, META, CYO

	Chrome	36 512 979-00 0010
	Brushed Platinum	36 512 979-06 0010
	Platinum	36 512 979-08 0010
	Dark Chrome	36 512 979-19 0010
	Light Gold	36 512 979-26 0010
	Brushed Light Gold	36 512 979-27 0010
	Brushed Durabrass (23kt Gold)	36 512 979-28 0010
	Matte Black	36 512 979-33 0010
	Brushed Bronze	36 512 979-42 0010
	Brushed Champagne (22kt Gold)	36 512 979-46 0010
	Champagne (22kt Gold)	36 512 979-47 0010
	Brushed Chrome	36 512 979-93 0010
	Brushed Dark Platinum	36 512 979-99 0010

**Required miscellaneous**



**Concealed wall installation box -** 35 206 970-90  
 •max. recess depth 173 mm 0010  
 •min. recess depth 100 mm

**Recommended miscellaneous**



**xGRID Attachment set for integrating in the dry wall construction -** 12 340 970 90

**Required miscellaneous**



**xGRID Installation track 555 mm -** 12 360 970 90

36 512 979

mm [inches]

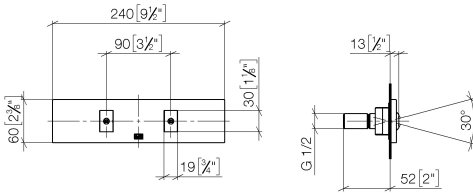

**Flow rate chart**

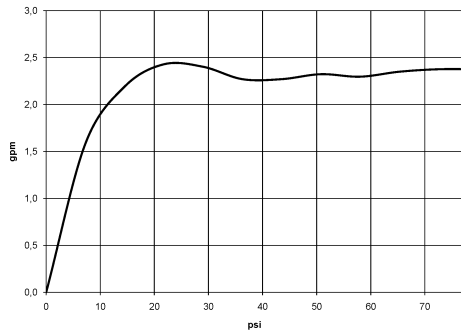

**Codes & Standards**

ASME  
A112.18.1/CSA  
B125.1

California Energy  
Commission  
(CEC)



## WATER FAN horizontal Concealed body spray - Chrome

---

IMO

36 512 979

### Certificates

---

IAPMO\_4976 (4).

36 512 979

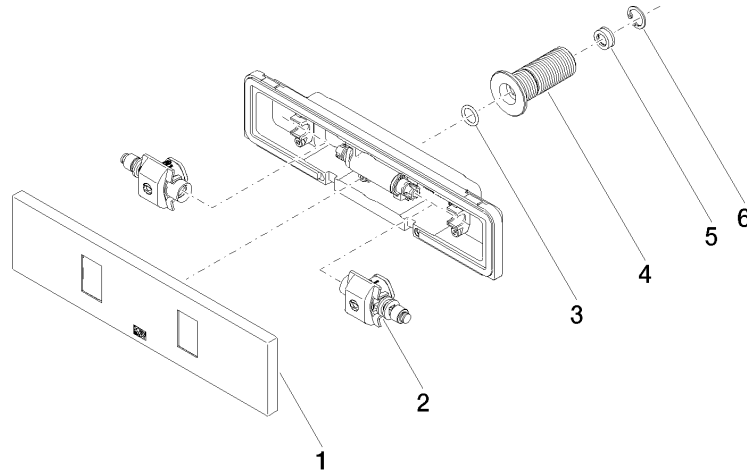

### Spare parts list

No.	Item Number	Name	Quantity used	Delivery time
1	90 27 99 002 00-00	insert	1	10
2	90 31 10 012 00 90	insert	1	2
3	09 14 10 003 90	seal	1	2
4	09 24 05 015 90	nipple	1	2
5	09 23 01 165 90	flow reducer	1	2
6	09 16 01 014 90	ring	1	2