













36 512 979



- forceful flat water jet
- horizontal water jet
- cover plate 240 x 60 mm
- water jet adjustable
- 1/2" connection
- max. flow 6.8 l/min
- This product reduces water consumption by % (compared to requirements of EPAAct '92)
- This product can contribute to Water Use Reduction in LEED® Green Building Rating
- This product can help a building meet the requirements of Green Building Rating Systems, e.g. LEED®, BREEAM®, DGNB

Fits: IMO, LULU, MADISON, MEM, TARA, CL.1, LISSÉ, VAIA, META, CYO

	Brushed Light Gold	36 512 979-27 0010
	Chrome	36 512 979-00 0010
	Brushed Platinum	36 512 979-06 0010
	Platinum	36 512 979-08 0010
	Dark Chrome	36 512 979-19 0010
	Light Gold	36 512 979-26 0010
	Brushed Durabronze (23kt Gold)	36 512 979-28 0010
	Matte Black	36 512 979-33 0010
	Brushed Bronze	36 512 979-42 0010
	Brushed Champagne (22kt Gold)	36 512 979-46 0010
	Champagne (22kt Gold)	36 512 979-47 0010
	Brushed Chrome	36 512 979-93 0010
	Brushed Dark Platinum	36 512 979-99 0010



WATER FAN horizontal Concealed body spray - Brushed Light Gold

IMO

36 512 979

mm [inches]

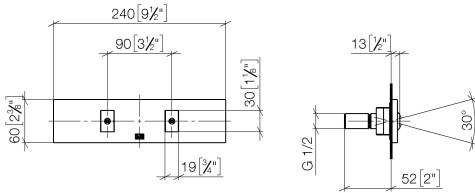

Flow rate chart

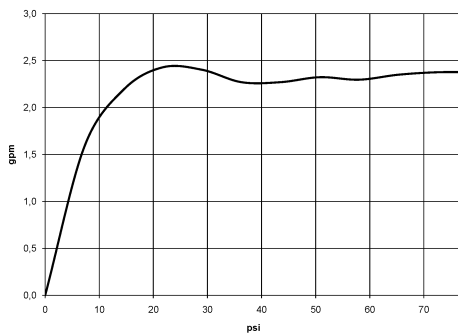

Codes & Standards

ASME
A112.18.1/CSA
B125.1

California Energy
Commission
(CEC)

36 512 979

Product version from 10/1/2023

Parts for other finishes can be found here: [Chrome](#)

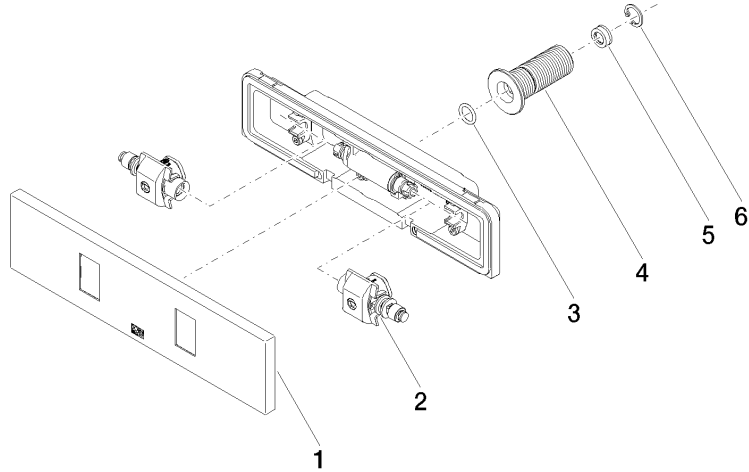



WATER FAN horizontal Concealed body spray - Brushed Light Gold

IMO

36 512 979

Spare parts list

Product version from 10/1/2023

No.	Item Number	Name	Quantity used	Delivery time
	90 27 99 002 00-27	insert	6	30