

WATER CURVE Concealed body spray - Brushed Dark Platinum







IMO

36 514 979



- AQUAPRESSURE FLOW, max. flow rate 6.8 l/min (at 3 bar)
- water jet adjustable
- cover plate 120 x 60 mm
- 1/2" connection
- This product reduces water consumption by % (compared to requirements of EPAAct '92)
- This product can contribute to Water Use Reduction in LEED® Green Building Rating
- This product can help a building meet the requirements of Green Building Rating Systems, e.g. LEED®, BREEAM®, DGNB

Fits: IMO, LULU, MADISON, MEM, TARA, CL.1, LISSÉ, VAIA, META, CYO

| | | |
|--|--------------------------------|--------------------|
|  | Brushed Dark Platinum | 36 514 979-99 0010 |
|  | Chrome | 36 514 979-00 0010 |
|  | Brushed Platinum | 36 514 979-06 0010 |
|  | Platinum | 36 514 979-08 0010 |
|  | Dark Chrome | 36 514 979-19 0010 |
|  | Light Gold | 36 514 979-26 0010 |
|  | Brushed Light Gold | 36 514 979-27 0010 |
|  | Brushed Durabronze (23kt Gold) | 36 514 979-28 0010 |
|  | Matte Black | 36 514 979-33 0010 |
|  | Brushed Bronze | 36 514 979-42 0010 |
|  | Brushed Champagne (22kt Gold) | 36 514 979-46 0010 |
|  | Champagne (22kt Gold) | 36 514 979-47 0010 |
|  | Brushed Chrome | 36 514 979-93 0010 |

Required miscellaneous

Concealed adapter -

35 080 970-90
0010



36 514 979

mm [inches]

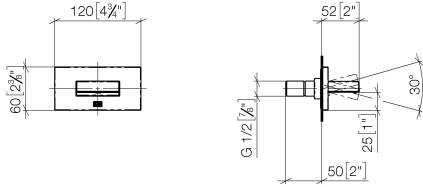

Flow rate chart

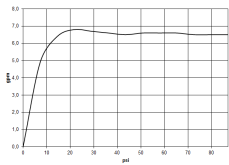

Trajectory diagram

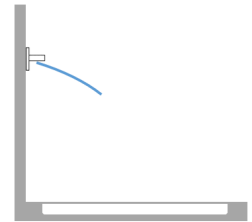
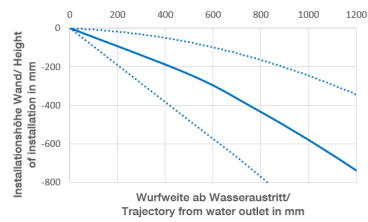

Codes & Standards

ASME A112.18.1

ASME
A112.18.1/CSA
B125.1

California Energy
Commission
(CEC)

cUPC



WATER CURVE Concealed body spray - Brushed Dark Platinum

IMO

36 514 979

Certificates

IAPMO_4976

36 514 979

Product version from 10/1/2023

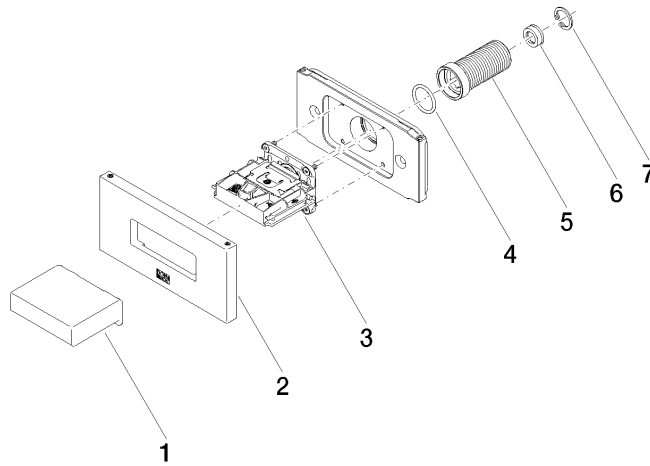



WATER CURVE Concealed body spray - Brushed Dark Platinum

IMO

36 514 979

Spare parts list

Product version from 10/1/2023

| No. | Item Number | Name | Quantity used | Delivery time |
|-----|-----------------|--------|---------------|---------------|
| | 09 17 01 230-99 | casing | 7 | 30 |