

36 515 979















- HORIZONTAL RAIN, max. flow rate 6 l/min (at 3 bar)
- with anti-scale system
- cover plate 120 x 120 mm
- This product can help a building meet the requirements of Green Building Rating Systems, e.g. LEED®, BREEAM®, DGNB
- WRAS 1304001

Flow restrictor (8.3 l/min) to extend shower jet from approx. 500 mm to approx. 1000 mm

Flow restrictor (8.3 l/min) to extend shower jet from approx. 500 mm to approx. 1000 mm

Fits: IMO, LULU, MADISON, MEM, TARA, CL.1, LISSÉ, VAIA, META, CYO

	Brushed Platinum	36 515 979-06
	Chrome	36 515 979-00
	Platinum	36 515 979-08
	Dark Chrome	36 515 979-19
	Light Gold	36 515 979-26
	Brushed Light Gold	36 515 979-27
	Brushed Durabronze (23kt Gold)	36 515 979-28
	Matte Black	36 515 979-33
	Brushed Bronze	36 515 979-42
	Brushed Champagne (22kt Gold)	36 515 979-46
	Champagne (22kt Gold)	36 515 979-47
	Brushed Chrome	36 515 979-93
	Brushed Dark Platinum	36 515 979-99

Required miscellaneous



WATER POINTS Adapter plate - 12 305 970 90
 • adapter plate for mounting concealed rough parts 35 205 970 90 on the xGRID installation track.

Required miscellaneous



Concealed wall installation box - 35 205 970-90 0010
 • max. recess depth 110 mm
 • min. recess depth 85 mm

Recommended miscellaneous



xGRID Attachment set for integrating in the dry wall construction - 12 340 970 90

Required miscellaneous



xGRID Installation track 555 mm - 12 360 970 90

36 515 979

mm [inches]

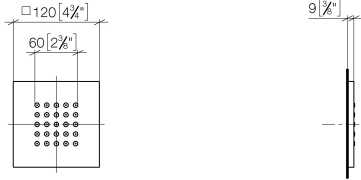

Flow rate chart

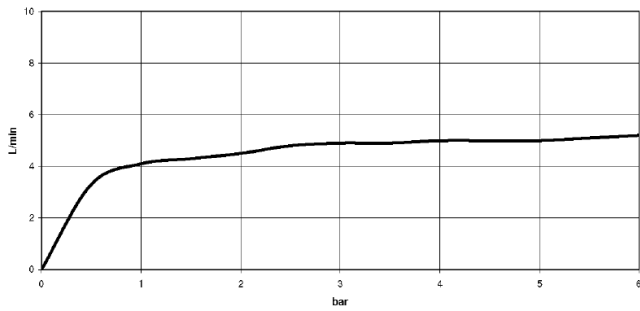

Trajectory diagram

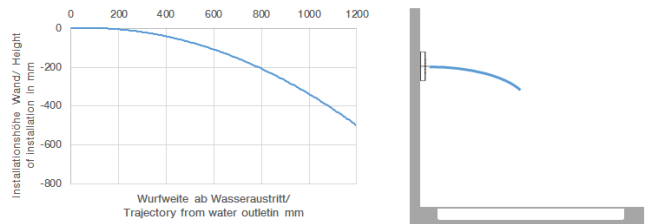

Codes & Standards

ASME A112.18.1	ASME A112.18.1/CSA B125.1	California Energy Commission (CEC)	cUPC
DIN 4109	ISO 3822	Scottish Water Byelaws	UK Water Supply Regulations

Ü-Zeichen



WATER POINTS Concealed body spray FlowReduce - Brushed Platinum

IMO

36 515 979

Certificates

WRAS_1304

LGA_18

IAPMO_4976

36 515 979

Product version from 4/1/2024

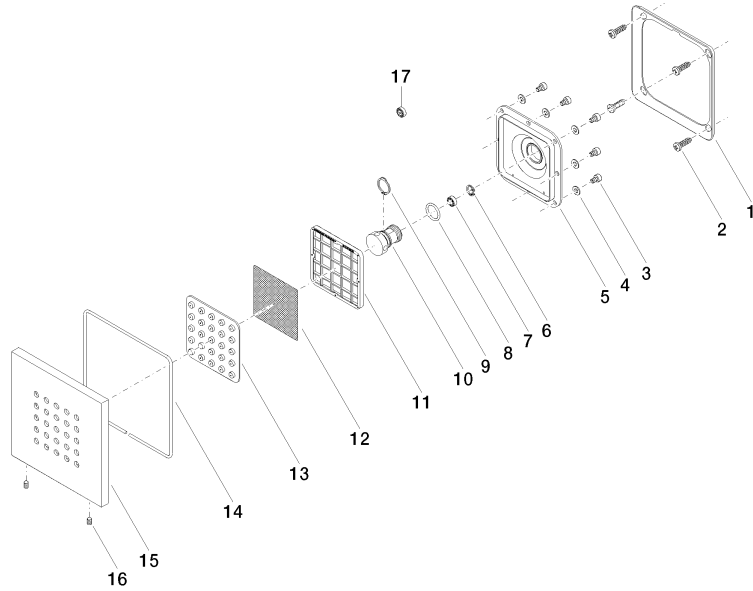



WATER POINTS Concealed body spray FlowReduce - Brushed Platinum

IMO

36 515 979

Spare parts list

Product version from 4/1/2024

No.	Item Number	Name	Quantity used	Delivery time
	09 28 01 024 90	holder	34	2