







**CL.1 Wall valve anti-clockwise closing hot 1/2" - Brushed Platinum**

CL.1

36 607 707



- rosette 60 x 60 mm
- with hot marking
- head part with cut-to-length spindle and sleeve

	Brushed Platinum	36 607 707-06
	Chrome	36 607 707-00
	Dark Chrome	36 607 707-19
	Brushed Champagne (22kt Gold)	36 607 707-46
	Champagne (22kt Gold)	36 607 707-47
	Brushed Dark Platinum	36 607 707-99

**Required miscellaneous**



**Wall valve 1/2" -** 35 607 970-90  
 •max. recess depth 150 mm 0010  
 •min. recess depth 105 mm

36 607 707

mm [inches]

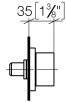

Codes & Standards

ADA

ASME  
A112.18.1/CSA  
B125.1

Certificates

DVGW\_DW-  
6501DN0116.

IAPMO\_4976 (1).

LGA\_29931.

WRAS\_2010066.

LGA\_29932.

36 607 707

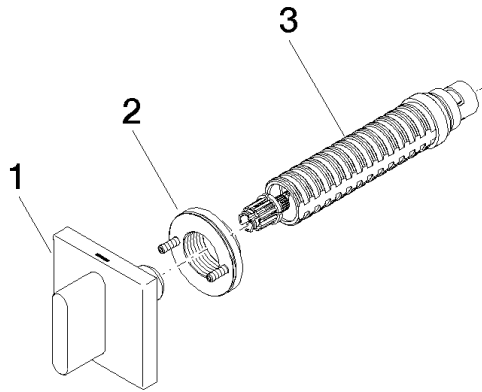

### Spare parts list

No.	Item Number	Name	Quantity used	Delivery time
1	90 20 70 051 03-06	handle ( hot )	1	10
2	90 21 02 108 00 90	disc	1	2
3	90 90 03 142 00 90	top	1	2