







CL.1 Wall valve anti-clockwise closing hot 1/2" - Champagne (22kt Gold)

CL.1

36 607 707



- rosette 60 x 60 mm
- with hot marking
- head part with cut-to-length spindle and sleeve
- WRAS 2010066

	Champagne (22kt Gold)	36 607 707-47
	Chrome	36 607 707-00
	Brushed Platinum	36 607 707-06
	Dark Chrome	36 607 707-19
	Brushed Champagne (22kt Gold)	36 607 707-46
	Brushed Dark Platinum	36 607 707-99



CL.1 Wall valve anti-clockwise closing hot 1/2" - Champagne (22kt Gold)

CL.1

36 607 707

mm [inches]

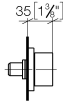

Codes & Standards

ADA	ASME A112.18.1/CSA B125.1	DIN 4109	ISO 3822
Scottish Water Byelaws	UK Water Supply Regulations	Ü-Zeichen	

Certificates

WRAS_2010 LGA_29

36 607 707

Product version from 10/14/2020

Parts for other
finishes can be found
here: [Chrome](#)

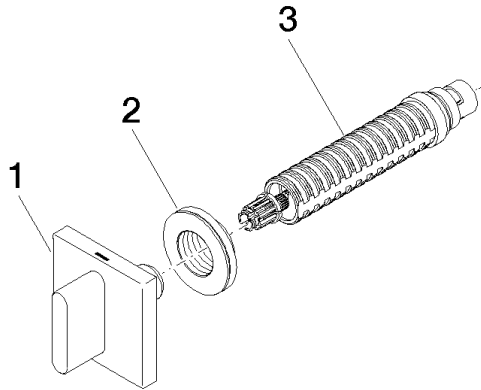



CL.1 Wall valve anti-clockwise closing hot 1/2" - Champagne (22kt Gold)

CL.1

36 607 707

Spare parts list

Product version from 10/14/2020