





CL.1 Wall valve anti-clockwise closing hot 1/2" - Brushed Dark Platinum

CL.1

36 607 707 Product version from 10/14/2020



- rosette 60 x 60 mm
- with hot marking
- head part with cut-to-length spindle and sleeve
- WRAS

	Brushed Dark Platinum	36 607 707-99
	Chrome	36 607 707-00
	Brushed Platinum	36 607 707-06
	Dark Chrome	36 607 707-19
	Brushed Champagne (22kt Gold)	36 607 707-46
	Champagne (22kt Gold)	36 607 707-47

Required miscellaneous

	Wall valve 1/2" - •max. recess depth mm •min. recess depth mm	35 607 970-90 0010
---	--	-----------------------

36 607 707 Product version from 10/14/2020

mm [inches]

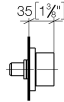

Codes & Standards

ADA	ASME A112.18.1/CSA B125.1	DIN 4109	EN 200
ISO 3822	Scottish Water Byelaws	UK Water Supply Regulations	Ü-Zeichen

Certificates

DVGW_DW- 6501DN0	LGA_29	WRAS_2010	LGA_29
---------------------	--------	-----------	--------

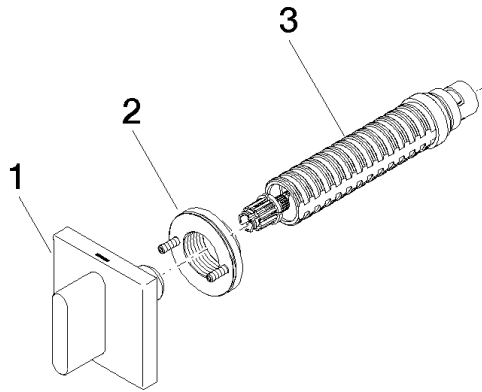

Spare parts list

No.	Item Number	Name	Quantity used	Delivery time
1	90 20 70 051 03-99	handle (hot)	1	30
2	90 21 02 108 00 90	disc	1	2
3	90 90 03 142 00 90	top	1	2