

Wall valve anti-clockwise closing hot 1/2" - Chrome







CL.1

36 607 717



- rosette 60 x 60 mm
- with hot marking
- head part with cut-to-length spindle and sleeve
- WRAS 2010066

Fits: CL.1, CYO

	Chrome	36 607 717-00
	Brushed Platinum	36 607 717-06
	Dark Chrome	36 607 717-19
	Brushed Durabross (23kt Gold)	36 607 717-28
	Brushed Champagne (22kt Gold)	36 607 717-46
	Champagne (22kt Gold)	36 607 717-47
	Brushed Dark Platinum	36 607 717-99

Required miscellaneous



- | | |
|---------------------------|---------------|
| Wall valve 1/2" - | 35 607 970-90 |
| ●max. recess depth 150 mm | 0010 |
| ●min. recess depth 105 mm | |

36 607 717

mm [inches]

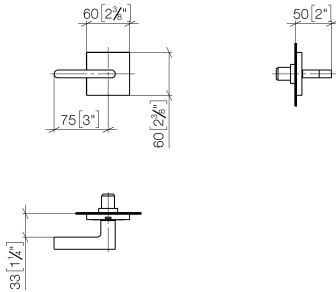

Codes & Standards

ADA	ASME A112.18.1	ASME A112.18.1/CSA B125.1	cUPC
DIN 4109	EN 200	ISO 3822	Scottish Water Byelaws
UK Water Supply Regulations	Ü-Zeichen		

Certificates

IAPMO_4976	DVGW_DW- 6501DN0	WRAS_2010	LGA_29	LGA_29
------------	---------------------	-----------	--------	--------

36 607 717

Product version up to 10/14/2020

Product version from 10/14/2020

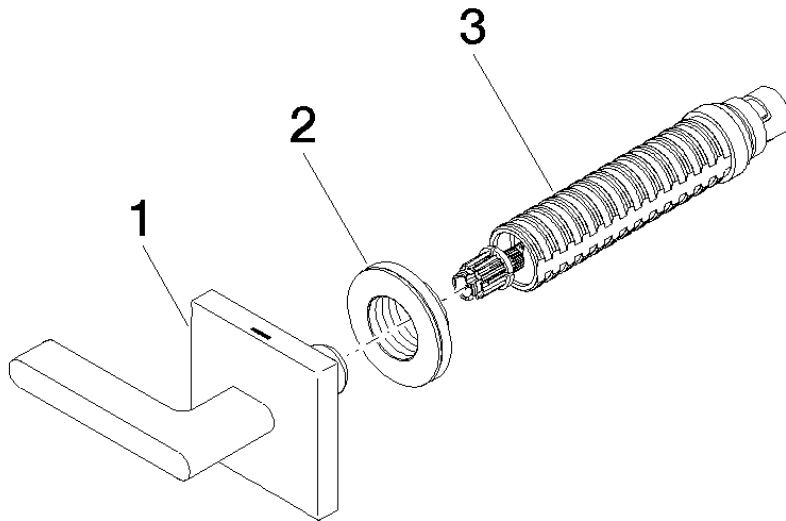



Wall valve anti-clockwise closing hot 1/2" - Chrome

CL.1

36 607 717

Spare parts list

Product version up to 10/14/2020

Product version from 10/14/2020

No.	Item Number	Name	Quantity used	Delivery time
	90 20 70 057 05-00	handle (hot)	3	10