









**SYMETRICS Wall valve anti-clockwise closing 1/2" - Brushed Platinum**

IMO

36 607 985



- rosette 60 x 60 mm
- head part with cut-to-length spindle and sleeve
- WRAS 2011026, 2010066

	Brushed Platinum	36 607 985-06
	Chrome	36 607 985-00
	Platinum	36 607 985-08
	Dark Chrome	36 607 985-19
	Brushed Light Gold	36 607 985-27
	Brushed Durabronze (23kt Gold)	36 607 985-28
	Brushed Chrome	36 607 985-93
	Brushed Dark Platinum	36 607 985-99

**Required miscellaneous**



- Wall valve 1/2" -** 35 607 970-90
- max. recess depth 145 mm
  - min. recess depth 75 mm
- 0010

36 607 985

mm [inches]

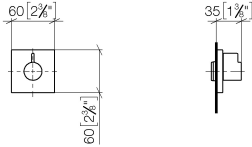

**Codes & Standards**

ADA	ASME A112.18.1	ASME A112.18.1/CSA B125.1	cUPC
DIN 4109	EN 1111	EN 200	ISO 3822
Scottish Water Byelaws	UK Water Supply Regulations	Ü-Zeichen	

**Certificates**

IAPMO_4976	DVGW_DW- 6501DN0	WRAS_2010	LGA_29	LGA_29
DVGW_DW- 6512DN0	WRAS_2011			

36 607 985

Product version from 6/1/2024

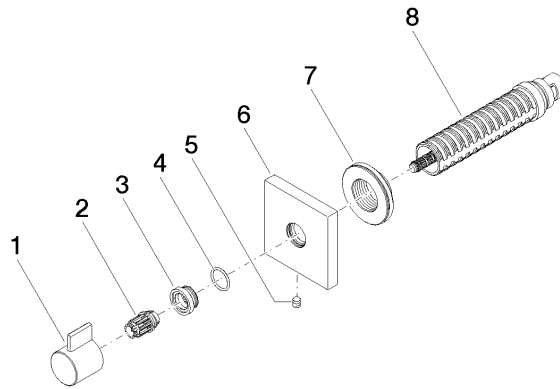



# SYMETRICS Wall valve anti-clockwise closing 1/2" - Brushed Platinum

IMO

36 607 985

## Spare parts list

### Product version from 6/1/2024

No.	Item Number	Name	Quantity used	Delivery time
	09 20 98 002-06	handle	8	10