









36 607 985



- rosette 60 x 60 mm
- head part with cut-to-length spindle and sleeve
- WRAS 2011026, 2010066

	Dark Chrome	36 607 985-19
	Chrome	36 607 985-00
	Brushed Platinum	36 607 985-06
	Platinum	36 607 985-08
	Brushed Light Gold	36 607 985-27
	Brushed Durabronze (23kt Gold)	36 607 985-28
	Brushed Chrome	36 607 985-93
	Brushed Dark Platinum	36 607 985-99



# SYMETRICS Wall valve anti-clockwise closing 1/2" - Dark Chrome

IMO

36 607 985

mm [inches]

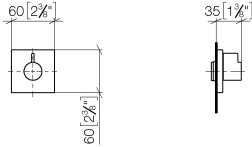

## Codes & Standards

ADA	ASME A112.18.1/CSA B125.1	DIN 4109	EN 1111
ISO 3822	Scottish Water Byelaws	UK Water Supply Regulations	Ü-Zeichen

## Certificates

WRAS_2010	LGA_29	DVGW_DW- 6512DNO	WRAS_2011
-----------	--------	---------------------	-----------

36 607 985

Parts for other  
finishes can be found  
here: [Chrome](#)

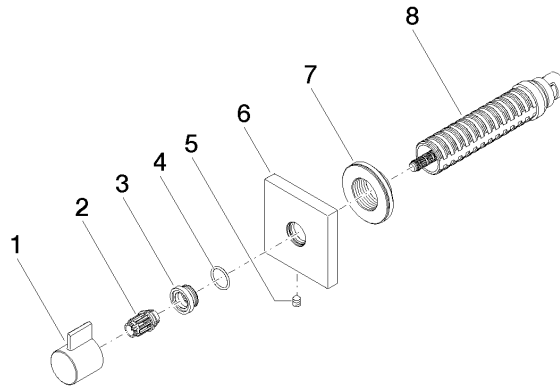



## SYMETRICS Wall valve anti-clockwise closing 1/2" - Dark Chrome

---

IMO

36 607 985

### **Spare parts list**