







CL.1 Wall-mounted single-lever basin mixer without pop-up waste - Brushed Platinum

CL.1

36 860 705



- 198mm projection
- fixed spout
- rectangular spray pattern with 40 individual jets
- hole diameter spout 37 mm
- hole diameter single-lever mixer 57 mm
- rosette 80 x 80 mm
- max. flow 4.5 l/min
- lead-free
- This product can help a building meet the requirements of Green Building Rating Systems, e.g. LEED®, BREEAM®, DGNB

	Brushed Platinum	36 860 705-06
	Chrome	36 860 705-00
	Dark Chrome	36 860 705-19
	Brushed Champagne (22kt Gold)	36 860 705-46
	Champagne (22kt Gold)	36 860 705-47
	Brushed Dark Platinum	36 860 705-99

Required miscellaneous



Concealed wall-mounted single-lever mixer - 35 860 970-90 0010

- max. recess depth 95 mm
- min. recess depth 80 mm
- Rough can be rotated to position the lever on top or to the left of the spout.



CL.1 Wall-mounted single-lever basin mixer without pop-up waste - Brushed Platinum

CL.1

36 860 705
mm [inches]

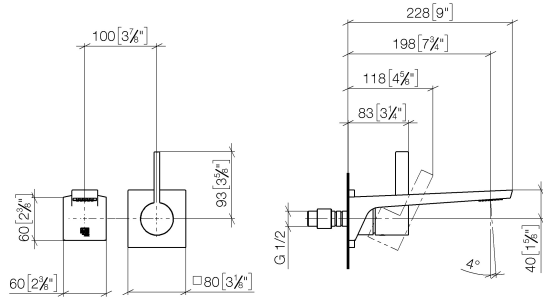

Flow rate chart

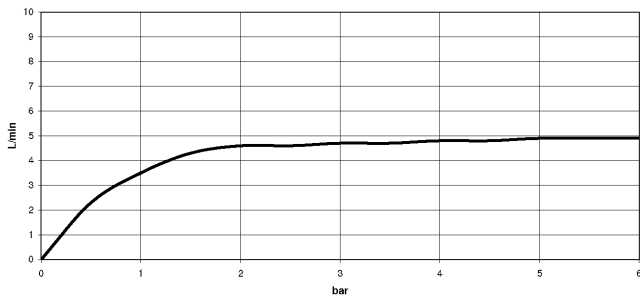

Codes & Standards

ADA

ASME
A112.18.1/CSA
B125.1

California Energy
Commission
(CEC)

NSF/ANSI 372

NSF/ANSI/CAN
61

Water Sense





CL.1 Wall-mounted single-lever basin mixer without pop-up waste - Brushed
Platinum

CL.1

36 860 705

Certificates

IAPMO_N-4976 (2). DVGW_DW- IAPMO_8834 (2). IAPMO_6397 (2). IAPMO_4976 (1).
6512DN0435.
LGA_29900.

36 860 705

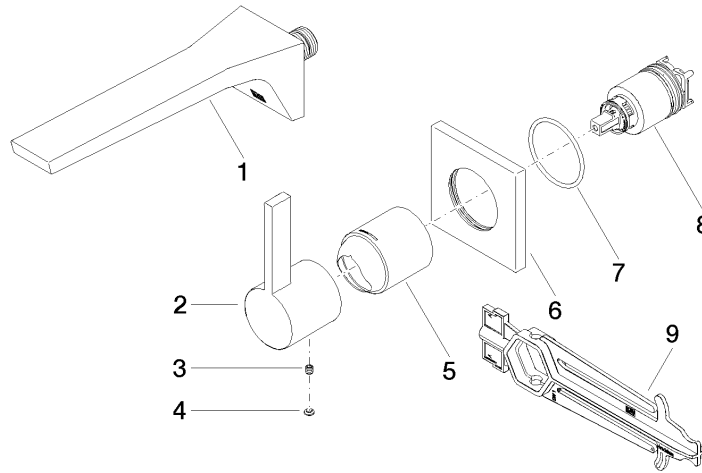

Spare parts list

No.	Item Number	Name	Quantity used	Delivery time
1	13 800 705-06	CL.1 Wall-mounted basin spout without pop-up waste - Brushed Platinum	1	10
2	09 20 70 050-06	handle	1	10
3	90 31 11 030 00 90	pin	1	2
4	90 31 20 087 00-06	plug	1	10
5	09 11 02 288-06	cover	1	10
6	09 27 78 039-06	rosette	1	10
7	90 14 10 049 00 90	seal	1	2
8	90 15 05 064 01 90	cartridge	1	2
9	90 30 09 064 00 90	key	1	2