















## Pressure balanced valve without diverter

36 900 660 Product version from 5/1/2024

- cover plate Ø 150 mm



	Brushed Platinum	36 900 660-06
	Chrome	36 900 660-00
	Platinum	36 900 660-08
	Dark Chrome	36 900 660-19
	Light Gold	36 900 660-26
	Brushed Light Gold	36 900 660-27
	Brushed Durabronze (23kt Gold)	36 900 660-28
	Matte Black	36 900 660-33
	Brushed Dark Brass	36 900 660-39
	Brushed Bronze	36 900 660-42
	Brushed Champagne (22kt Gold)	36 900 660-46
	Champagne (22kt Gold)	36 900 660-47
	Brushed Chrome	36 900 660-93
	Brushed Dark Platinum	36 900 660-99

### Required miscellaneous



- Pressure balanced valve -** 35 920 970 90
- min. recess depth mm
  - max. recess depth mm

## Pressure balanced valve without diverter

36 900 660 Product version from 5/1/2024

mm [inches]

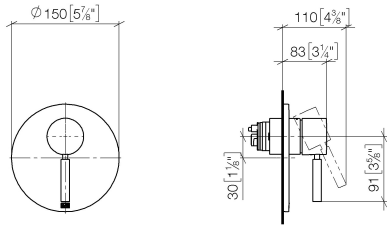

### Flow rate chart

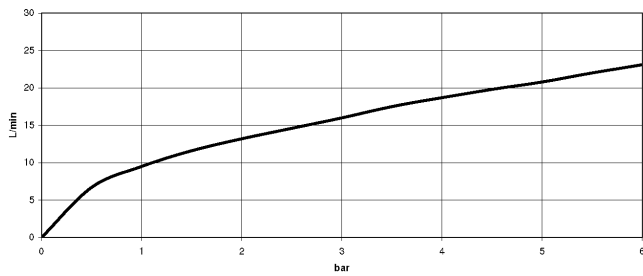

### Codes & Standards

ASME A112.18.1

cUPC



## Pressure balanced valve without diverter

---

36 900 660 Product version from 5/1/2024

### Certificates

---

IAPMO\_4976 (

## Pressure balanced valve without diverter

36 900 660 Product version from 5/1/2024

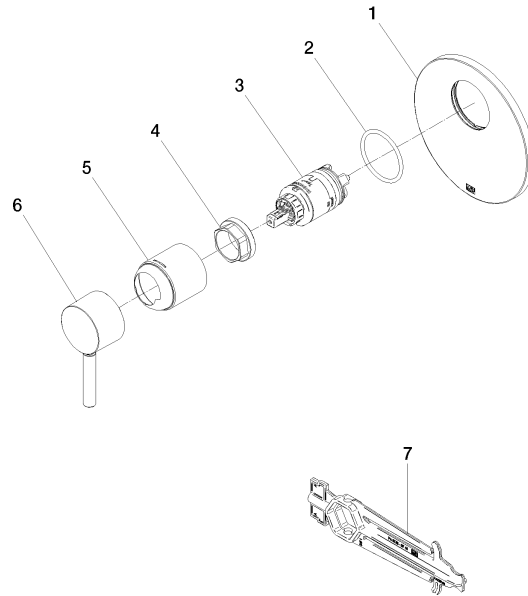

### Spare parts list

No.	Item Number	Name	Quantity used	Delivery time
1	09 11 02 262-06	plate	1	10
2	09 14 10 084 90	seal	1	2
3	90 15 05 069 00 90	cartridge	1	2
4	09 24 04 448 90	nut	1	2
5	09 11 02 260-06	sleeve	1	10
6	90 20 66 004 00-06	handle	1	10
7	90 30 09 064 00 90	key	1	2