





SERIES-VARIOUS AQUAHALO Rain panel - Matte Black

41 750 979



- exposed trim parts
- Rain panel with 3 different flow modes
- AQUACIRCLE RAIN: Circular rain curtain, max. flow rate 6.8 l/min (at 3 bar)
- TEMPEST RAIN: Natural rain, max. flow rate 6.8 l/min (at 3 bar)
- DIAMOND RAIN: Ring of rain, max. flow rate 6.8 l/min (at 3 bar)
- Outer diameter: 605 mm, opening diameter: 465 mm
- Weight: 6 kg
- central LED Spot 3000 K
- Protection rating IP67
- Not suitable for use in a steam room.

To meet the North American plumbing standards, this application must be installed with three-way diverter (rough included).

	Matte Black	41 750 979-33 0010
	Chrome	41 750 979-00 0010
	Brushed Platinum	41 750 979-06 0010
	Brushed Champagne (22kt Gold)	41 750 979-46 0010
	Champagne (22kt Gold)	41 750 979-47 0010

Required miscellaneous



SERIES-VARIOUS AQUAHALO 35 750 970-33
Concealed ceiling installation box 0010
- Matte Black

- concealed rough parts
- Pre-assembly kit for three-way diverter included
- Ceiling installation enclosure 605 x 605 x 95 mm
- Weight: 10 kg
- min. recess depth 110 mm

SERIES-VARIOUS AQUAHALO Rain panel - Matte Black

41 750 979

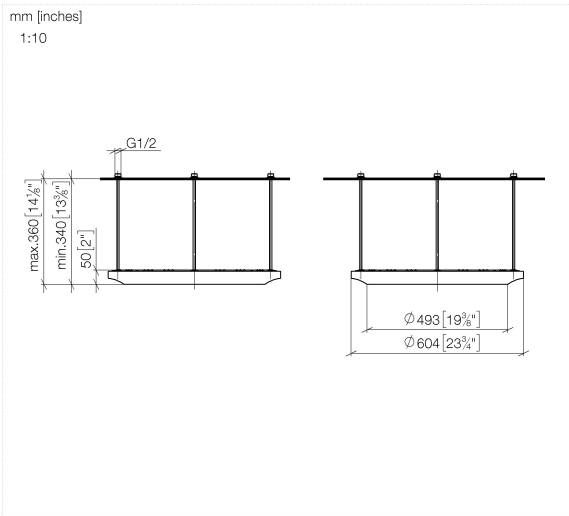

Flow rate chart

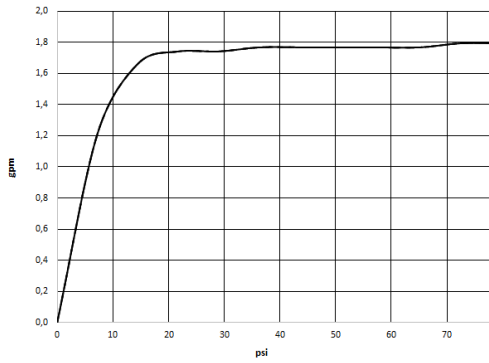



SERIES-VARIOUS AQUAHALO Rain panel - Matte Black

41 750 979

Product version from 4/1/2024

Parts for other finishes can be found here: [Chrome](#)

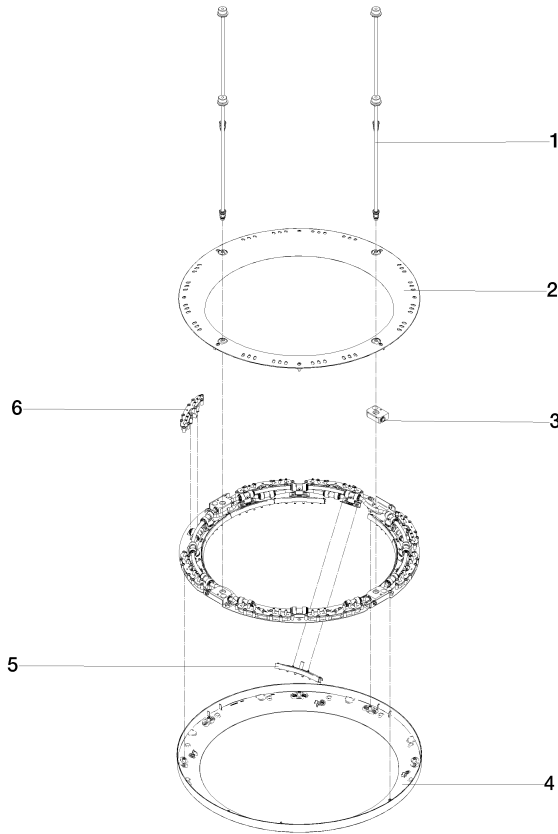



SERIES-VARIOUS AQUAHALO Rain panel - Matte Black

41 750 979

Spare parts list

Product version from 4/1/2024

No.	Item Number	Name	Quantity used	Delivery time
	90 28 22 605 01-33	distributor	13	30