

Tumbler holder wall model - Brushed Champagne (22kt Gold)















MADISON

83 400 979

- crystal glass, transparent
- width 60mm
- height 120 mm
- 110mm projection



Fits: MADISON, MEM, TARA, CL.1, LISSÉ,
VAIA, META, CYO

	Brushed Champagne (22kt Gold)	83 400 979-46
	Chrome	83 400 979-00
	Brushed Platinum	83 400 979-06
	Platinum	83 400 979-08
	Durabress (23kt Gold)	83 400 979-09
	Dark Chrome	83 400 979-19
	Light Gold	83 400 979-26
	Brushed Light Gold	83 400 979-27
	Brushed Durabress (23kt Gold)	83 400 979-28
	Matte Black	83 400 979-33
	Brushed Bronze	83 400 979-42
	Champagne (22kt Gold)	83 400 979-47
	Brushed Chrome	83 400 979-93
	Brushed Dark Platinum	83 400 979-99

83 400 979

mm [inches]

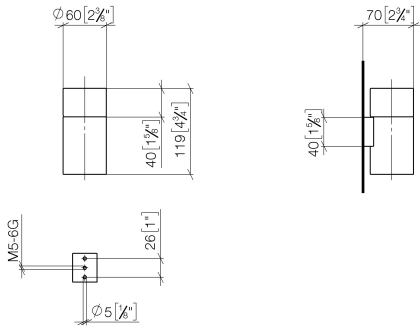

83 400 979

Parts for other finishes can be found here: [Chrome](#)

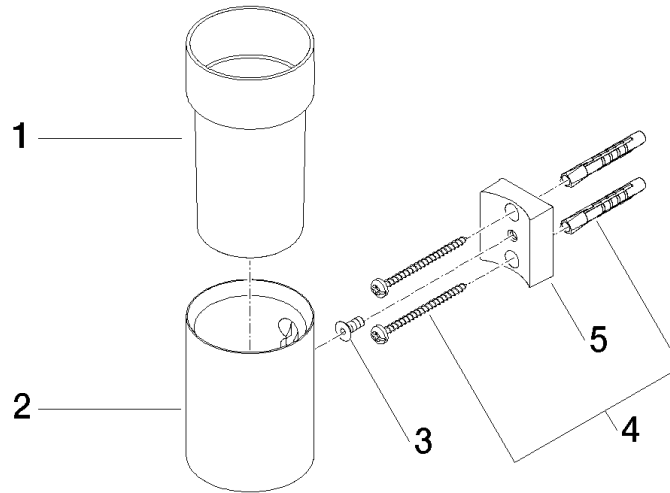

Spare parts list

No.	Item Number	Name	Quantity used	Delivery time
1	90 90 00 008 00 84	glass	1	2
2	08 17 97 569-46	holder	1	30
3	09 30 30 117 90	screw	1	2
4	05 30 31 025 00 90	fixing set	1	2
5	08 10 10 530-46	holder	1	30