







MADISON Tissue holder with cover - Brushed Platinum

83 510 361 Product version from 7/3/2016



- width 145mm
- height 90 mm
- 150mm projection

	Brushed Platinum	83 510 361-06
	Chrome	83 510 361-00
	Platinum	83 510 361-08
	Durabress (23kt Gold)	83 510 361-09
	Brushed Durabress (23kt Gold)	83 510 361-28
	Brushed Dark Platinum	83 510 361-99

MADISON Tissue holder with cover - Brushed Platinum

83 510 361 Product version from 7/3/2016

mm [inches]

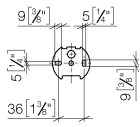
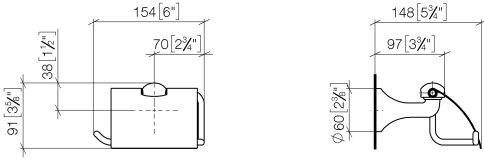

MADISON Tissue holder with cover - Brushed Platinum

83 510 361 Product version from 7/3/2016

Parts for other finishes can be found here: [Chrome](#)

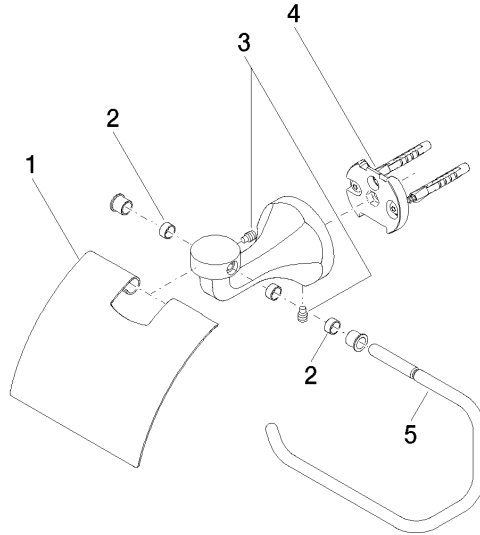

Spare parts list

No.	Item Number	Name	Quantity used	Delivery time
1	08 11 02 508-06	lid	1	10
2	08 18 40 505 90	sleeve	2	2
3	04 31 11 140 00 90	pin	2	2
4	05 17 97 507 00 90	fixing set	1	2
5	08 18 70 501-06	bow	1	10