

**CYO Wall-mounted basin mixer without pop-up waste - Durabronss / Brushed
Durabronss (23kt Gold)**

CYO

ST 010 206 2811



- 160mm projection
- fixed spout
- rectangular, air-enriched flow
- hole diameter valve 37 mm
- hole diameter spout 37 mm
- handle Ø 60mm
- max. flow 4.5 l/min
- lead-free
- with hot / cold marking
- This product can help a building meet the requirements of Green Building Rating Systems, e.g. LEED®, BREEAM®, DGNB

	Durabronss / Brushed Durabronss (23kt Gold)	ST 010 206 2811-38
	Chrome	ST 010 206 2811-00
	Brushed Platinum	ST 010 206 2811-06
	Dark Chrome	ST 010 206 2811-19
	Brushed Durabronss (23kt Gold)	ST 010 206 2811-28
	Platinum / Brushed Platinum	ST 010 206 2811-36
	Brushed Dark Platinum	ST 010 206 2811-99

Individual components of this set

You need the following components for this set

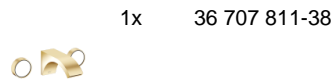
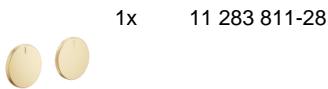



CYO Wall-mounted basin mixer without pop-up waste - Durabronss / Brushed
Durabronss (23kt Gold)

CYO

ST 010 206 2811

**CYO Wall-mounted basin mixer without pop-up waste - Durabron / Brushed
Durabron (23kt Gold)**

CYO

ST 010 206 2811



- with hot / cold marking
- for three-hole basin mixers and five-hole bath mixers

	Brushed Durabron (23kt Gold)	11 283 811-28
	Chrome	11 283 811-00
	Brushed Platinum	11 283 811-06
	Platinum	11 283 811-08
	Durabron (23kt Gold)	11 283 811-09
	Dark Chrome	11 283 811-19
	Brushed Champagne (22kt Gold)	11 283 811-46
	Champagne (22kt Gold)	11 283 811-47
	Brushed Dark Platinum	11 283 811-99



CYO Wall-mounted basin mixer without pop-up waste - Durabronss / Brushed
Durabronss (23kt Gold)

CYO

ST 010 206 2811

ST 010 206 2R11
Parts for other
finishes can be found
here: Chrome

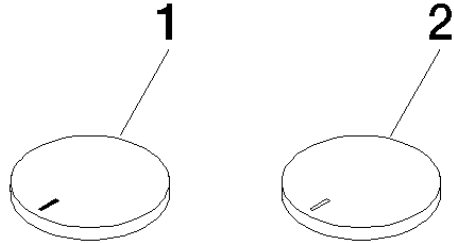

Spare parts list

No.	Item Number	Name	Quantity used	Delivery time
1	11 183 811-28	CYO Handle insert hot - Brushed Durabronss (23kt Gold)	1	20
2	11 184 811-28	CYO Handle insert cold - Brushed Durabronss (23kt Gold)	1	20

**CYO Wall-mounted basin mixer without pop-up waste - Durabron / Brushed
Durabron (23kt Gold)**

CYO







ST 010 206 2811



- 160mm projection
- fixed spout
- rectangular, air-enriched flow
- hole diameter valve 37 mm
- hole diameter spout 37 mm
- handle Ø 60mm
- max. flow 4.5 l/min
- lead-free
- This product can help a building meet the requirements of Green Building Rating Systems, e.g. LEED®, BREEAM®, DGNB
- WRAS 2111006

NOTE: The handle inserts must be ordered separately from the fittings!

NOTE: The handle inserts must be ordered separately from the fittings!

	Durabron / Brushed Durabron (23kt Gold)	36 707 811-38
	Chrome	36 707 811-00
	Brushed Platinum	36 707 811-06
	Dark Chrome	36 707 811-19
	Brushed Durabron (23kt Gold)	36 707 811-28
	Platinum / Brushed Platinum	36 707 811-36
	Brushed Dark Platinum	36 707 811-99

Required miscellaneous



**Concealed wall-mounted mixer
centred spout -** 35 700 970-90
0010

- max. recess depth 145 mm
- min. recess depth 85 mm

Required miscellaneous



**Concealed wall-mounted mixer
variable positioning -** 35 720 970-90
0010

- max. recess depth 145 mm
- min. recess depth 85 mm



CYO Wall-mounted basin mixer without pop-up waste - Durabronss / Brushed
Durabronss (23kt Gold)

CYO

ST 010 206 2811

ST 010 206 2R11
mm [inches]

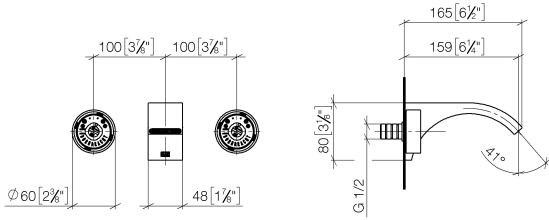

Flow rate chart

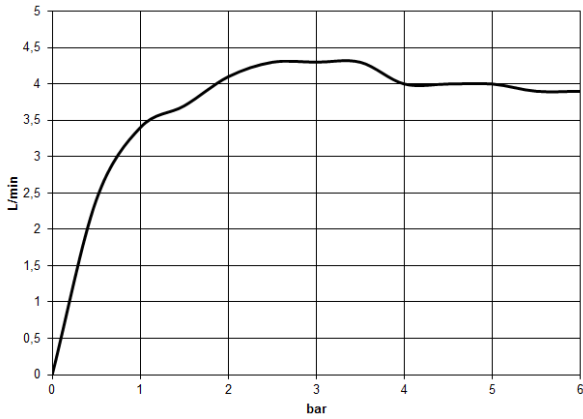

Codes & Standards

California Energy
Commission
(CEC)

Certificates

WRAS_2111006. IAPMO_N-4976 (2). IAPMO_6397 (2). LGA_38121.



CYO Wall-mounted basin mixer without pop-up waste - Durabronss / Brushed
Durabronss (23kt Gold)

CYO

ST 010 206 2811

ST 010 206 2811

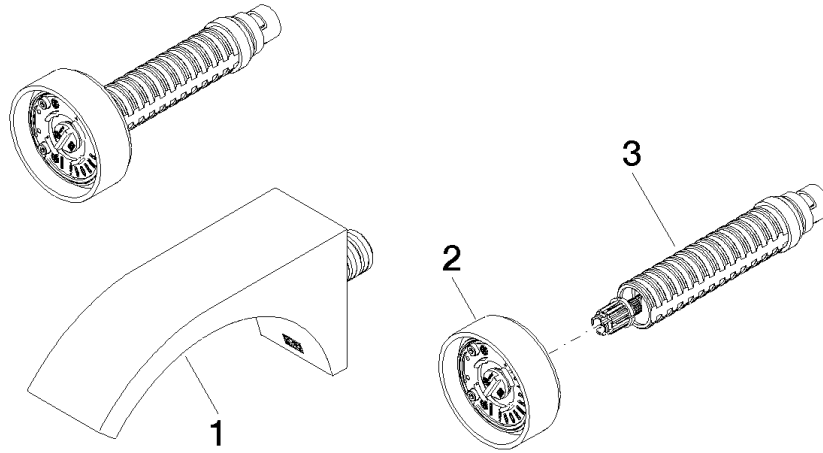

Spare parts list

No.	Item Number	Name	Quantity used	Delivery time
1	13 800 811-38	CYO Wall-mounted basin spout without pop-up waste - Durabron / Brushed Durabron (23kt Gold)	1	20
2	90 18 40 290 00-38	handle	1	20
3	90 90 03 171 01 90	top	1	2