

ST 050 305 9980





Fits: IMO, MEM, CL.1, CYO

- shower with fixed riser projection 453mm
- Rain shower: PURE RAIN, max. flow rate 6.8 l/min (at 3 bar)
- Function from: 6 l/min
- rain shower 300 x 240mm
- rain shower with anti-scale system
- Hand shower: COMPACT RAIN, max. flow rate 6.8 l/min (at 3 bar)
- spray head Ø 100mm
- rotary diverter with volume control and shut-off function
- slide-on rosettes Ø 70 mm
- height of fittings up to rain shower (bottom edge) 1009mm
- height of fittings up to top edge of elbow 1150mm
- gauge 150 mm - 13 mm
- metal shower hose 1750mm with integrated anti-twist protection
- 1/2" connection
- slide bar
- Pipe diameter 23.5 mm

Intrinsic protection against back flow.

NOTE: Hand shower sold separately. Please see hand shower options under the miscellaneous articles section of each series.

	Brushed Chrome	ST 050 305 9980-93 0010
	Chrome	ST 050 305 9980-00 0010
	Brushed Platinum	ST 050 305 9980-06 0010
	Platinum	ST 050 305 9980-08 0010
	Dark Chrome	ST 050 305 9980-19 0010
	Brushed Light Gold	ST 050 305 9980-27 0010
	Brushed Durabronze (23kt Gold)	ST 050 305 9980-28 0010
	Matte Black	ST 050 305 9980-33 0010
	Brushed Dark Platinum	ST 050 305 9980-99 0010

Individual components of this set

You need the following components for this set



1x 34 459 980-93 0010



1x 28 018 979-93 0010



SYMETRICS Showerpipe with shower thermostat - Brushed Chrome

IMO

ST 050 305 9980

ST 050 305 9980



Fits: IMO, MEM, CL.1, CYO

- shower with fixed riser projection 453mm
- overhead shower: rain flow
- rain shower 300 x 240mm
- rain shower with anti-scale system
- max. rainshower flow 6.8 l/min
- Function from: 6 l/min
- rotary diverter with volume control and shut-off function
- slide-on rosettes Ø 70 mm
- height of fittings up to rain shower (bottom edge) 1009mm
- height of fittings up to top edge of elbow 1150mm
- gauge 150 mm - 13 mm
- metal shower hose 1750mm with integrated anti-twist protection
- 1/2" connection
- slide bar
- Pipe diameter 23.5 mm
- quick clearing
- This product reduces water consumption by % (compared to requirements of EPAAct '92)
- This product can contribute to Water Use Reduction in LEED® Green Building Rating

Intrinsic protection against back flow.

NOTE: Hand shower sold separately. Please see hand shower options under the miscellaneous articles section of each series.

	Brushed Chrome	34 459 980-93 0010
	Chrome	34 459 980-00 0010
	Brushed Platinum	34 459 980-06 0010
	Platinum	34 459 980-08 0010
	Dark Chrome	34 459 980-19 0010
	Brushed Light Gold	34 459 980-27 0010
	Brushed Durabross (23kt Gold)	34 459 980-28 0010
	Matte Black	34 459 980-33 0010
	Brushed Champagne (22kt Gold)	34 459 980-46 0010
	Brushed Dark Platinum	34 459 980-99 0010

ST 050 305 9980

mm [inches]
1:10

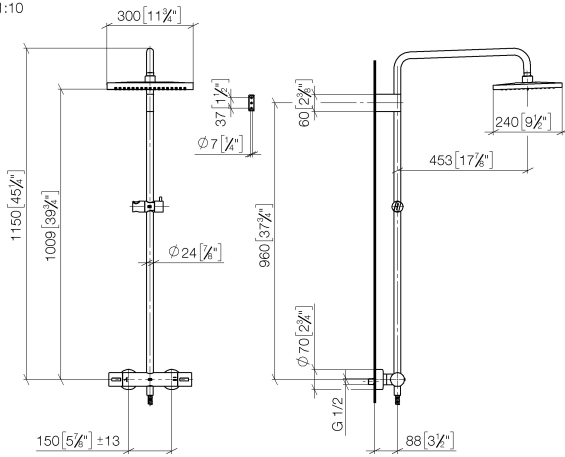

Flow rate chart

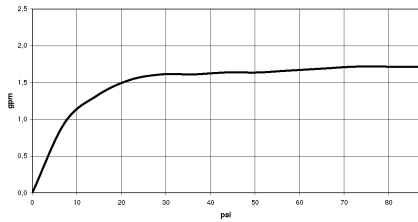

Codes & Standards

ASME
A112.18.1/CSA
B125.1

California Energy
Commission
(CEC)

ST 050 305 9980

Parts for other finishes can be found here: [Chrome](#)

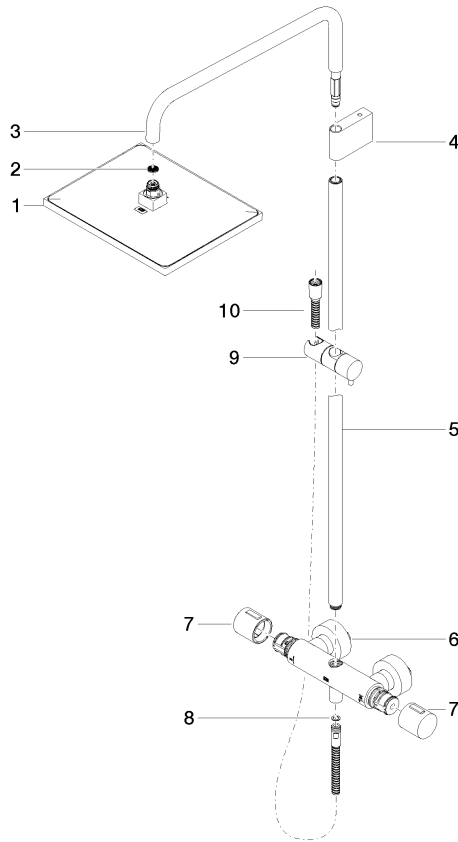

Spare parts list

No.	Item Number	Name	Quantity used	Delivery time
1	04 12 05 063 10-93	shower	1	20
2	09 23 01 039 90	sieve	1	2
3	90 28 22 348 00-93	pipe	1	20
4	90 17 11 150 00-93	holder	1	20
5	90 28 22 349 00-93	pipe	1	20
6	04 17 01 250 00-93	connection	1	20
7	90 17 33 015 00-93	handle	1	20
8	90 14 20 026 00 90	seal	1	2
9	12 570 970-93	Slide unit - Brushed Chrome	1	20
10	28 322 970-93	Metal shower hose 1/2" x 3/8" x 1750 mm - Brushed Chrome	1	20















ST 050 305 9980



Fits: IMO, LULU, MADISON, MEM, TARA, CL.1, LISSÉ, VAIA, META, CYO

- Three or five settings: COMPACT RAIN, COMPACT SOFT FLOW, COMPACT AQUAPRESSURE FLOW, max. flow rate 6.8 l/min (at 3 bar)
- with anti-scale system
- spray head Ø 100mm
- 1/2" connection
- Function from: 6 l/min
- This product reduces water consumption by % (compared to requirements of EPAct '92)
- This product can contribute to Water Use Reduction in LEED® Green Building Rating
- This product can help a building meet the requirements of Green Building Rating Systems, e.g. LEED®, BREEAM®, DGNB

Intrinsic protection against back flow.

	Brushed Chrome	28 018 979-93 0010
	Chrome	28 018 979-00 0010
	Brushed Platinum	28 018 979-06 0010
	Platinum	28 018 979-08 0010
	Dark Brass matt	28 018 979-16 0010
	Dark Bronze matt	28 018 979-17 0010
	Dark Chrome	28 018 979-19 0010
	Light Gold	28 018 979-26 0010
	Brushed Light Gold	28 018 979-27 0010
	Brushed Durabronze (23kt Gold)	28 018 979-28 0010
	Matte Black	28 018 979-33 0010
	Brushed Bronze	28 018 979-42 0010
	Brushed Champagne (22kt Gold)	28 018 979-46 0010
	Champagne (22kt Gold)	28 018 979-47 0010
	Brushed Dark Platinum	28 018 979-99 0010



SYMETRICS Showerpipe with shower thermostat - Brushed Chrome

IMO

ST 050 305 9980

ST 050 305 9980

mm [inches]

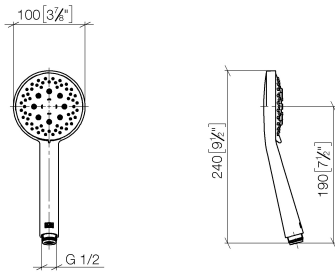

Flow rate chart

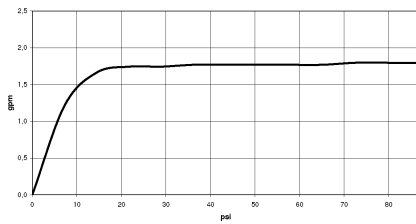

Codes & Standards

California Energy
Commission
(CEC)

Certificates

LGA_29984.



SYMETRICS Showerpipe with shower thermostat - Brushed Chrome

IMO

ST 050 305 9980

Spare parts list

No.	Item Number	Name	Quantity used	Delivery time
1	09 23 01 039 90	sieve	1	2