

ST 050 309 3892



- 420mm projection
- Rain shower: PURE RAIN, max. flow rate 6.8 l/min (at 3 bar)
- rain shower Ø 300 mm
- rain shower with anti-scale system
- Hand shower: COMPACT RAIN, max. flow rate 6.8 l/min (at 3 bar)
- Function from: 6.5 l/min
- spray head Ø 100mm
- rotary diverter for fixed-riser shower/hand shower
- height of fittings up to rain shower (bottom edge) 1007mm
- height of fittings up to top edge of elbow 1167mm
- rosette for shower holder Ø 55mm
- rosette for wall mounting Ø 57mm
- rosette for shower mixer Ø 65mm
- gauge 150 mm - 13 mm
- 1500 mm metal shower hose
- 1/2" connection
- Pipe diameter 20 mm

|  |                                |                    |
|--|--------------------------------|--------------------|
|  | Platinum                       | ST 050 309 3892-08 |
|  | Chrome                         | ST 050 309 3892-00 |
|  | Brushed Platinum               | ST 050 309 3892-06 |
|  | Dark Chrome                    | ST 050 309 3892-19 |
|  | Brushed Durabronze (23kt Gold) | ST 050 309 3892-28 |
|  | Matte Black                    | ST 050 309 3892-33 |
|  | Brushed Champagne (22kt Gold)  | ST 050 309 3892-46 |
|  | Champagne (22kt Gold)          | ST 050 309 3892-47 |
|  | Brushed Chrome                 | ST 050 309 3892-93 |
|  | Brushed Dark Platinum          | ST 050 309 3892-99 |

**Individual components of this set**

You need the following components for this set



1x 26 623 892-08 0010



1x 28 018 979-08 0010



## TARA Shower pipe with shower mixer 300 mm - Platinum

---

TARA

ST 050 309 3892

ST 050 309 3892



- shower with fixed riser projection 420mm
- overhead shower: rain flow
- rain shower Ø 300 mm
- rain shower with anti-scale system
- max. rainshower flow 6.8 l/min
- Function from: 6.5 l/min
- rotary diverter for fixed-riser shower/hand shower
- height of fittings up to rain shower (bottom edge) 1007mm
- height of fittings up to top edge of elbow 1167mm
- rosette for shower holder Ø 55mm
- rosette for wall mounting Ø 57mm
- rosette for shower mixer Ø 65mm
- gauge 150 mm - 13 mm
- 1500 mm metal shower hose
- 1/2" connection
- Pipe diameter 20 mm
- quick clearing

This article does not include a hand shower!

Intrinsic protection against back flow.

|  |                                     |                    |
|--|-------------------------------------|--------------------|
|  | Platinum                            | 26 623 892-08 0010 |
|  | Chrome                              | 26 623 892-00 0010 |
|  | Brushed Platinum                    | 26 623 892-06 0010 |
|  | Dark Chrome                         | 26 623 892-19 0010 |
|  | Brushed Durabronze<br>(23kt Gold)   | 26 623 892-28 0010 |
|  | Matte Black                         | 26 623 892-33 0010 |
|  | Brushed<br>Champagne (22kt<br>Gold) | 26 623 892-46 0010 |
|  | Champagne (22kt<br>Gold)            | 26 623 892-47 0010 |
|  | Brushed Chrome                      | 26 623 892-93 0010 |
|  | Brushed Dark<br>Platinum            | 26 623 892-99 0010 |



ST 050 309 3892

Parts for other finishes can be found here: [Chrome](#)

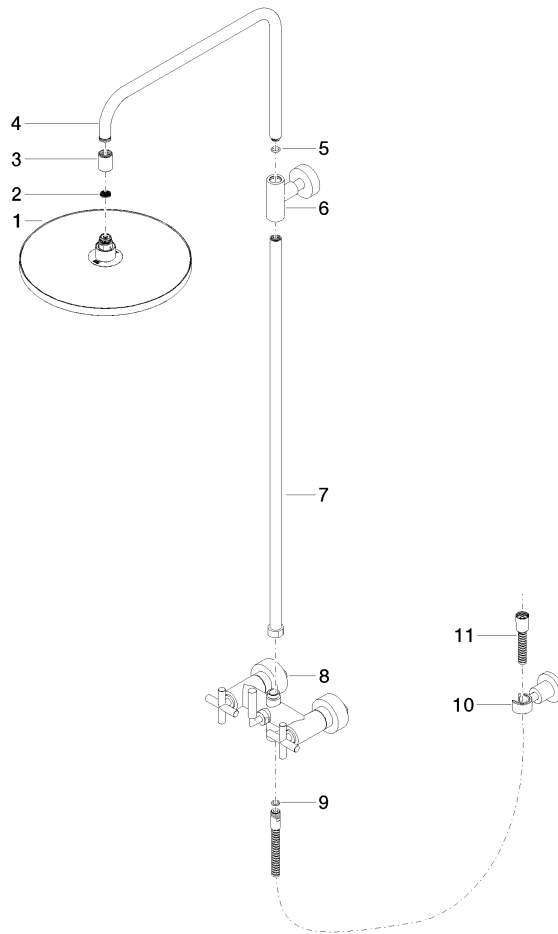

**Spare parts list**

| No.  | Item Number        | Name   | Quantity used | Delivery time |
|--|--------------------|--|---------------|---------------|
| 1  | 04 12 05 091 10-08 | shower   | 1             | 40            |
| 2  | 09 23 01 039 90    | sieve  | 1             | 2             |
| 3  | 09 24 03 177 20-08 | adaptor  | 1             | 40            |
| 4  | 04 28 22 101 20-08 | spout  | 1             | 40            |
| 5  | 90 14 10 011 00 90 | seal   | 1             | 2             |
| 6  | 90 17 11 037 00-08 | holder   | 1             | -             |
| Spare part can no longer be ordered, please order the replacement item |                    |  |               |               |
| 7  | 90 28 22 096 00-08 | pipe   | 1             | -             |
| Spare part can no longer be ordered, please order the replacement item |                    |  |               |               |
| 8  | 04 17 10 020 01-08 | fitting  | 1             | 40            |
| 9  | 90 14 20 026 00 90 | seal   | 1             | 2             |
| 10   | 28 050 892-08      | TARA Wall bracket - Platinum                       | 1             | 40            |
| 11   | 28 304 970-08      | Metal shower hose 1/2" x 3/8" x 1500 mm - Platinum | 1             | 40            |















ST 050 309 3892



Fits: IMO, LULU, MADISON, MEM, TARA, CL.1, LISSÉ, VAIA, META, CYO

- Three or five settings: COMPACT RAIN, COMPACT SOFT FLOW, COMPACT AQUAPRESSURE FLOW, max. flow rate 6.8 l/min (at 3 bar)
- with anti-scale system
- spray head Ø 100mm
- 1/2" connection
- Function from: 6 l/min
- This product reduces water consumption by % (compared to requirements of EPAct '92)
- This product can contribute to Water Use Reduction in LEED® Green Building Rating
- This product can help a building meet the requirements of Green Building Rating Systems, e.g. LEED®, BREEAM®, DGNB

Intrinsic protection against back flow.

|  |                                |                    |
|--|--------------------------------|--------------------|
|    | Platinum                       | 28 018 979-08 0010 |
|    | Chrome                         | 28 018 979-00 0010 |
|    | Brushed Platinum               | 28 018 979-06 0010 |
|    | Dark Brass matt                | 28 018 979-16 0010 |
|    | Dark Bronze matt               | 28 018 979-17 0010 |
|    | Dark Chrome                    | 28 018 979-19 0010 |
|    | Light Gold                     | 28 018 979-26 0010 |
|    | Brushed Light Gold             | 28 018 979-27 0010 |
|    | Brushed Durabronze (23kt Gold) | 28 018 979-28 0010 |
|    | Matte Black                    | 28 018 979-33 0010 |
|    | Brushed Bronze                 | 28 018 979-42 0010 |
|    | Brushed Champagne (22kt Gold)  | 28 018 979-46 0010 |
|   | Champagne (22kt Gold)          | 28 018 979-47 0010 |
|  | Brushed Chrome                 | 28 018 979-93 0010 |
|  | Brushed Dark Platinum          | 28 018 979-99 0010 |



## TARA Shower pipe with shower mixer 300 mm - Platinum

---

TARA

ST 050 309 3892

ST 050 309 3892

mm [inches]

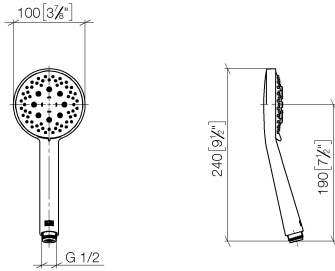

Flow rate chart

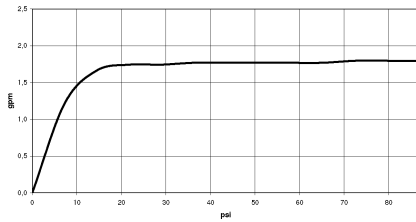

Codes & Standards

California Energy  
Commission  
(CEC)

Certificates

LGA\_29984.



ST 050 309 3892

### Spare parts list

| No. | Item Number     | Name  | Quantity used | Delivery time |
|-----|-----------------|-------|---------------|---------------|
| 1   | 09 23 01 039 90 | sieve | 1             | 2             |