

ST 050 611 6979



Fits: LULU, MADISON, TARA, LISSÉ, VAIA, META

- LAMINAR FLOW, max. flow rate 15 l/min (at 3 bar)
- rosette Ø 70 mm
- holder for Kneipp hose
- hose nozzle with sleeve M33
- with holding ring
- 1/2" wall elbow

	Chrome	ST 050 611 6979-00
	Brushed Platinum	ST 050 611 6979-06
	Platinum	ST 050 611 6979-08
	Dark Chrome	ST 050 611 6979-19
	Brushed Durabronz (23kt Gold)	ST 050 611 6979-28
	Matte Black	ST 050 611 6979-33
	Brushed Champagne (22kt Gold)	ST 050 611 6979-46
	Champagne (22kt Gold)	ST 050 611 6979-47
	Brushed Chrome	ST 050 611 6979-93
	Brushed Dark Platinum	ST 050 611 6979-99

Individual components of this set

You need the following components for this set



1x 27 820 979-00



1x 28 285 979-00



WATER TUBE Kneipp wall elbow - Chrome

LULU

ST 050 611 6979

ST 050 611 6979



Fits: LULU, MADISON, TARA, LISSÉ, VAIA, META

- LAMINAR FLOW, max. flow rate 15 l/min (at 3 bar)
- rosette Ø 70 mm
- holder for Kneipp hose
- 1/2" wall elbow
- without hose

Intrinsic protection against back flow.

Product change as of 1.4.2023: max. flow 15 l/min

Intrinsic protection against back flow.

Product change as of 1.4.2023: max. flow 15 l/min

	Chrome	27 820 979-00
	Brushed Platinum	27 820 979-06
	Platinum	27 820 979-08
	Dark Chrome	27 820 979-19
	Brushed Durabronze (23kt Gold)	27 820 979-28
	Matte Black	27 820 979-33
	Brushed Bronze	27 820 979-42
	Brushed Champagne (22kt Gold)	27 820 979-46
	Champagne (22kt Gold)	27 820 979-47
	Brushed Chrome	27 820 979-93
	Brushed Dark Platinum	27 820 979-99

Required miscellaneous

	Concealed adapter -	35 080 970-90 0010
---	----------------------------	-----------------------

Required miscellaneous

	WATER TUBE Kneipp hose white 2000 mm - Chrome	28 285 979-00
	●with holding ring	
	●hose nozzle with sleeve M33	

Required miscellaneous

	WATER TUBE Kneipp hose black 2000 mm - Chrome	28 286 979-00
	●with holding ring	
	●hose nozzle with sleeve M33	

ST 050 611 6979

mm [inches]

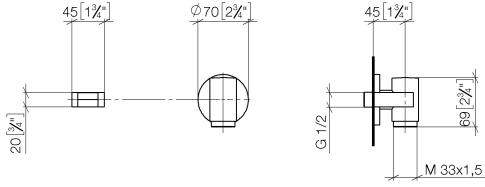

Flow rate chart

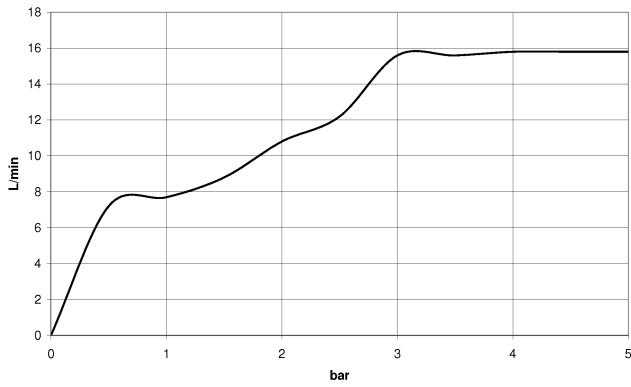

Certificates

Belgaqua_21-381-
27_7.

ST 050 611 6979

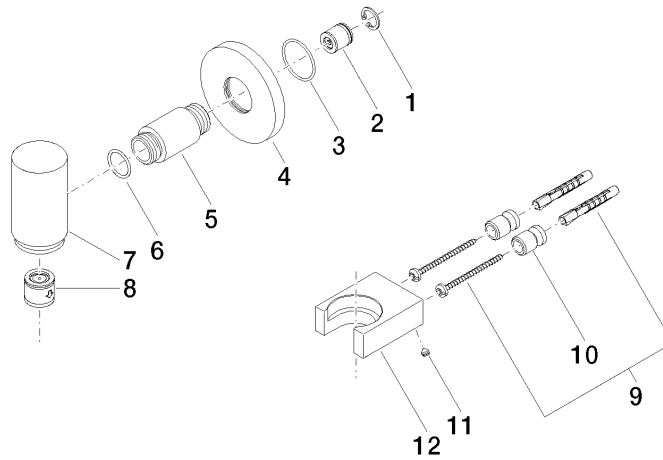

Spare parts list

No.	Item Number	Name	Quantity used	Delivery time
1	09 16 01 014 90	ring	1	2
2	09 23 01 046 90	back-flow preventer	1	2
3	09 14 10 135 90	seal	1	2
4	09 27 97 020-00	rosette	1	10
5	09 24 04 138-00	nipple	1	60
6	09 14 10 053 90	seal	1	2
7	09 11 03 051-00	connection	1	10
8	90 23 01 045 00 90	back-flow preventer	1	2
9	05 17 20 726 02 90	fixing set	1	2
10	08 17 20 726 90	holder	2	2
11	09 31 11 148 90	pin	2	2
12	09 17 20 023-00	holder	1	10

ST 050 611 6979



- hose nozzle with sleeve M33
- with holding ring

	Chrome	28 285 979-00
	Brushed Platinum	28 285 979-06
	Platinum	28 285 979-08
	Dark Chrome	28 285 979-19
	Brushed Durabronze (23kt Gold)	28 285 979-28
	Matte Black	28 285 979-33
	Brushed Champagne (22kt Gold)	28 285 979-46
	Champagne (22kt Gold)	28 285 979-47
	Brushed Chrome	28 285 979-93
	Brushed Dark Platinum	28 285 979-99



WATER TUBE Kneipp wall elbow - Chrome

LULU

ST 050 611 6979

ST 050 611 6979

mm [inches]

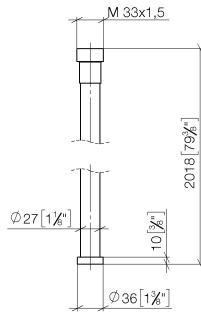

Flow rate chart

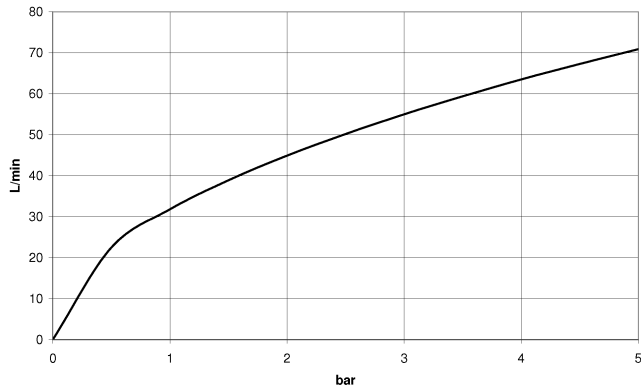

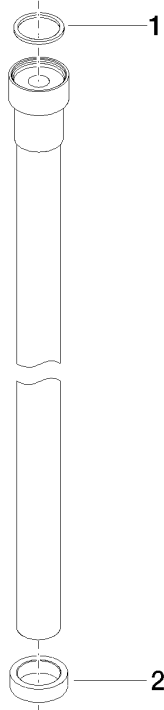

Spare parts list

No.	Item Number	Name	Quantity used	Delivery time
1	09 14 20 003 90	seal	1	2
2	09 28 10 116-12	ring	1	30