







10 710 970

- Betätigung für ein Becken
- inklusive Adapter für den Bowdenzug

Passt zu ELIO, ENO, MEM, META SQUARE, SYNC, TARA und TARA ULTRA



Passt zu: ELIO, MEM, TARA, TARA ULTRA, META SQUARE

	Platin gebürstet	10 710 970-06
	Chrom	10 710 970-00
	Platin	10 710 970-08
	Messing (23kt Gold)	10 710 970-09
	Dark Chrome	10 710 970-19
	Messing gebürstet (23kt Gold)	10 710 970-28
	Schwarz matt	10 710 970-33
	Champagne gebürstet (22kt Gold)	10 710 970-46
	Champagne (22kt Gold)	10 710 970-47
	Chrom gebürstet (Edelstahl-Look)	10 710 970-93
	Dark Platinum gebürstet	10 710 970-99

10 710 970

mm [inches]

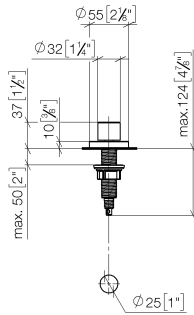

10 710 970

Ersatzteile für die  
anderen  
Oberflächenvarianten  
finden Sie hier:  
Chrom

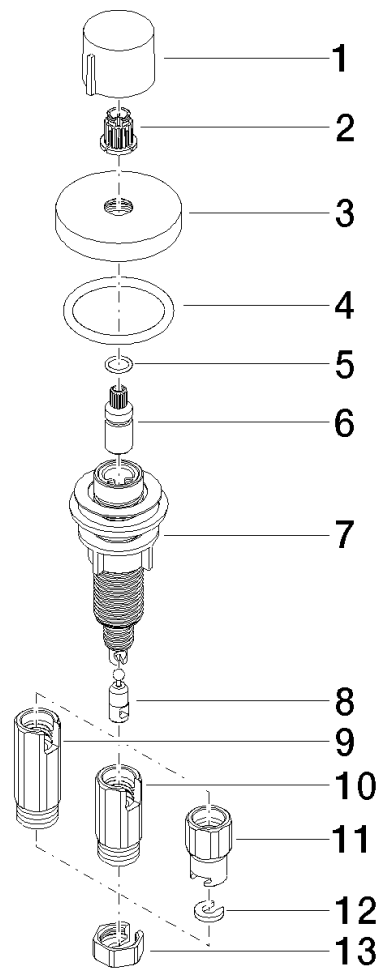

**Ersatzteilstückliste**

Nr.	Artikelnummer	Benennung	Verbaumenge	Lieferzeit
1	09 20 97 030-06	Griff	1	10
2	90 12 12 002 00 90	Rastbuchse	1	2
3	09 27 87 006-06	Rosette	1	10
4	90 14 10 043 00 90	Dichtung	1	2
5	09 14 10 042 90	Dichtung	1	2
6	09 29 06 087-06	Spindel	1	-
Ersatzteil nicht mehr bestellbar, bitte bestellen Sie den Nachfolgeartikel				
7	04 30 01 029 00 90	Adapter	1	2
8	09 24 03 175 90	Adapter	1	2
9	09 11 10 073-07	Anschluss	1	30
10	09 11 10 074-07	Anschluss	1	30
11	09 11 10 079-07	Anschluss	1	30
12	09 30 11 087 90	Scheibe	1	2
13	09 23 30 024-07	Mutter	1	30