







20 000 705

- Bohrungsdurchmesser Seitenventil 32 mm
- Rosette 60 x 60 mm
- mit Kaltkennzeichnung



	Dark Platinum gebürstet	20 000 705-99
	Chrom	20 000 705-00
	Platin gebürstet	20 000 705-06
	Dark Chrome	20 000 705-19
	Champagne gebürstet (22kt Gold)	20 000 705-46
	Champagne (22kt Gold)	20 000 705-47

20 000 705

mm [inches]

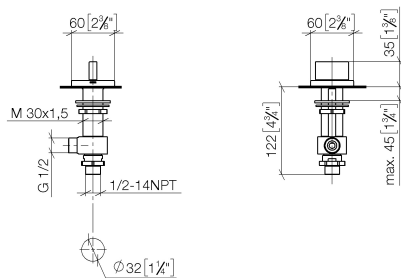

### Durchflussdiagramm

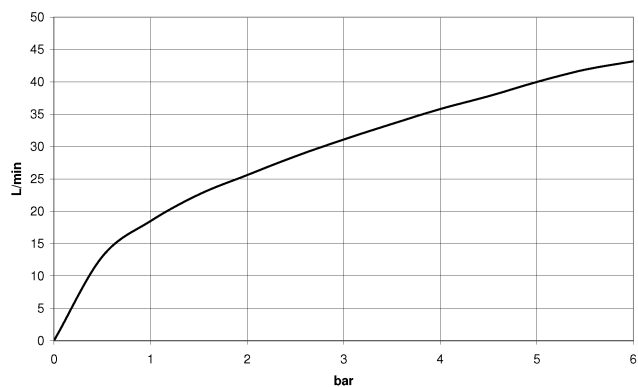

### Zertifikate

WRAS\_2103001. LGA\_28688. IAPMO\_4976 (4).

20 000 705

Ersatzteile für die  
anderen  
Oberflächenvarianten  
finden Sie hier:  
Chrom

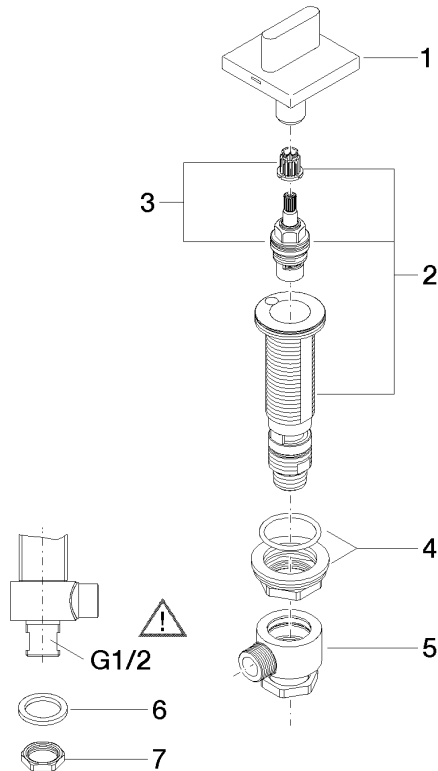

### Ersatzteilstückliste

Nr.	Artikelnummer	Benennung	Verbaumenge	Lieferzeit
1	90 20 70 051 04-99	Griff ( cold )	1	30
2	04 17 11 058 33 90	Seitenteil	1	2
3	90 90 03 133 00 90	Oberteil	1	2
4	04 23 10 032 78 90	Befestigungssatz	1	2
5	04 17 11 023 10 90	Verteiler	1	2
6	90 23 30 040 00-99	Verschraubung	1	30
7	09 30 11 059 90	Scheibe	1	2
8	09 23 10 012 90	Mutter	1	2