

26 413 979



Passt zu: IMO, LULU, MEM, TARA, CL.1, LISSÉ, VAIA, META, CYO

- Wandrohr mit Schieber
- Rohrdurchmesser 18 mm
- Stichmaß 853 mm
- Metallbrauseschlauch 1750 mm mit integriertem Verdreherschutz
- Brauseschlauchanschluss 3/8"

Dieser Artikel enthält keine Handbrause!

	Chrom	26 413 979-00
	Platin gebürstet	26 413 979-06
	Platin	26 413 979-08
	Dark Chrome	26 413 979-19
	Light Gold	26 413 979-26
	Light Gold gebürstet	26 413 979-27
	Messing gebürstet (23kt Gold)	26 413 979-28
	Schwarz matt	26 413 979-33
	Bronze gebürstet	26 413 979-42
	Champagne gebürstet (22kt Gold)	26 413 979-46
	Champagne (22kt Gold)	26 413 979-47
	Chrom gebürstet	26 413 979-93
	Dark Platin gebürstet	26 413 979-99

26 413 979

Empfohlenes Zubehör

	UP-Wandwinkel - •Max. Einbautiefe 163 mm •Min. Einbautiefe 90 mm	35 085 970 90
---	---	---------------

Empfohlenes Zubehör

	LISSÉ Wandanschlussbogen - Chrom	28 450 845-00
---	---	---------------

Benötigtes Zubehör

	Handbrause - Chrom •Durchfluss max. 15 l/min (bei 3 Bar)	28 016 979-00
---	--	---------------

Benötigtes Zubehör

	Handbrause FlowReduce - Chrom •Durchfluss max. 6,8 l/min (bei 3 Bar)	28 016 979-00 0010
---	--	-----------------------

Benötigtes Zubehör

	Handbrause FlowReduce - Chrom •Durchfluss max. 6,8 l/min (bei 3 Bar)	28 012 979-00 0010
---	--	-----------------------

Benötigtes Zubehör

	Handbrause FlowReduce - Chrom •Durchfluss max. 6,8 l/min (bei 3 Bar)	28 018 979-00 0010
---	--	-----------------------

Empfohlenes Zubehör

	Wandanschlussbogen - Chrom	28 450 980-00
---	-----------------------------------	---------------

Benötigtes Zubehör

	Handbrause - Chrom •Durchfluss max. 15 l/min (bei 3 Bar)	28 015 979-00
---	--	---------------

Benötigtes Zubehör

	Handbrause - Chrom •Durchfluss max. 15 l/min (bei 3 Bar)	28 012 979-00
---	--	---------------

Benötigtes Zubehör

	Handbrause - Chrom •Durchfluss max. 15 l/min (bei 3 Bar)	28 017 979-00
---	--	---------------

Benötigtes Zubehör

	Handbrause - Chrom •Durchfluss max. 15 l/min (bei 3 Bar)	28 018 979-00
---	--	---------------

26 413 979

mm [inches]

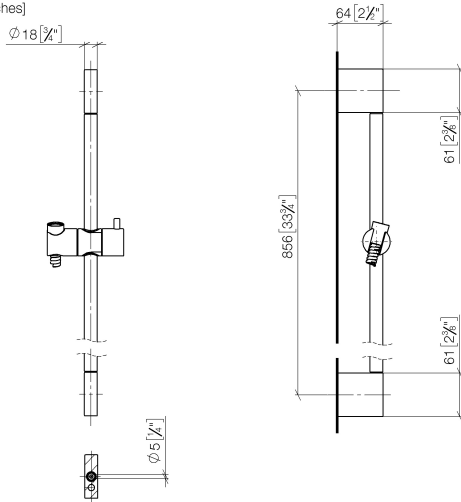

Zertifikate

WRAS_2009048. ACS_20 ACC LY 738. IAPMO_4976 (1).

26 413 979

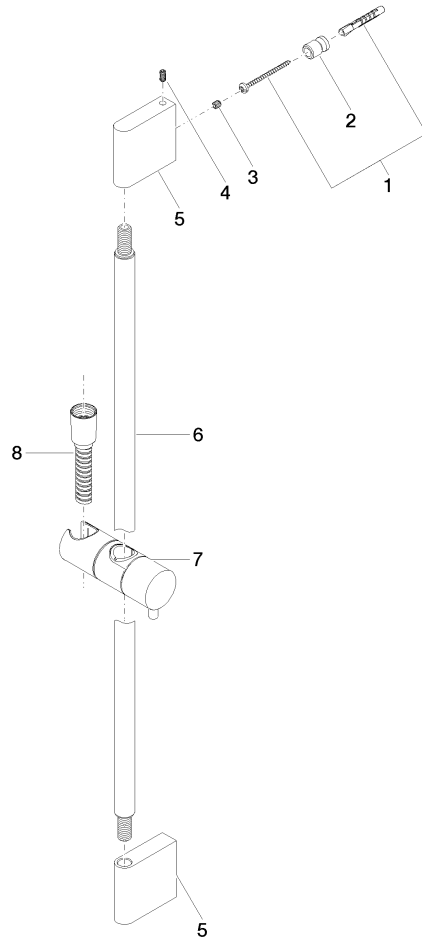

Ersatzteilstückliste

Nr.	Artikelnummer	Benennung	Verbaumenge	Lieferzeit
1	05 17 20 726 02 90	Befestigungssatz	2	2
2	08 17 20 726 90	Halter	2	2
3	09 31 11 049 90	Stift	2	2
4	04 31 11 113 00 90	Stift	2	2
5	08 17 97 054-00	Halter	2	10
6	90 28 22 597 00-00	Halter	1	10
7	12 580 970-00	Schieber - Chrom	1	10
8	28 322 970-00	Metall-Brauseschlauch 1/2" x 3/8" x 1750 mm - Chrom	1	2