

TARA Shower Pipe ohne Handbrause FlowReduce 220 mm - Platin gebürstet

26 633 892 Produktversion ab 4/1/2024



- Ausladung Standbrause 420 mm
- Kopfbrause: Regenstrahl
- Regenbrause Ø 220 mm
- Regenbrause mit Antikalk-System
- Durchfluss Regenbrause max. 7 l/min (bei 3 Bar)
- Drehumstellung Standbrause/ Handbrause
- Höhe Armatur bis Regenbrause (Unterkante) 1007 mm
- Höhe Armatur bis Oberkante Bogen 1167 mm
- Rosette für Brausehalter Ø 55 mm
- Rosette für Wandbefestigung Ø 57 mm
- Rosette für Brausebatterie Ø 65 mm
- Stichmaß 150 mm ± 13 mm
- Metallbrauseschlauch 1500 mm
- Anschluss 1/2"
- Rohrdurchmesser 20 mm
- mit Leerlauf-Funktion
- Dieses Produkt leistet einen Beitrag zur Erfüllung der Vorgaben von nachhaltigen Gebäudezertifizierungen, z.B. LEED®, BREEAM®, DGNB

Dieser Artikel enthält keine Handbrause!

Eigensicher gegen Rückfließen.

	Platin gebürstet	26 633 892-06
	Chrom	26 633 892-00
	Platin	26 633 892-08
	Dark Chrome	26 633 892-19
	Messing gebürstet (23kt Gold)	26 633 892-28
	Schwarz matt	26 633 892-33
	Bronze gebürstet	26 633 892-42
	Champagne gebürstet (22kt Gold)	26 633 892-46
	Champagne (22kt Gold)	26 633 892-47
	Chrom gebürstet	26 633 892-93
	Dark Platin gebürstet	26 633 892-99

TARA Shower Pipe ohne Handbrause FlowReduce 220 mm - Platin gebürstet

26 633 892 Produktversion ab 4/1/2024

Benötigtes Zubehör

	Handbrause - Platin gebürstet	28 015 979-06
---	--------------------------------------	---------------

Benötigtes Zubehör

	Handbrause - Platin gebürstet	28 012 979-06
---	--------------------------------------	---------------

Benötigtes Zubehör

	Handbrause FlowReduce - Platin gebürstet	28 012 979-06 0010
---	---	-----------------------

Benötigtes Zubehör

	Handbrause - Platin gebürstet	28 018 979-06
---	--------------------------------------	---------------

Benötigtes Zubehör

	SERIENNEUTRAL Handbrause FlowReduce - Platin gebürstet	28 027 979-06 0010
---	---	-----------------------

Benötigtes Zubehör

	SERIENNEUTRAL Handbrause FlowReduce - Platin gebürstet	28 025 979-06 0010
---	---	-----------------------

Benötigtes Zubehör

	Handbrause - Platin gebürstet	28 016 979-06
---	--------------------------------------	---------------

Benötigtes Zubehör

	Handbrause FlowReduce - Platin gebürstet	28 016 979-06 0010
---	---	-----------------------

Benötigtes Zubehör

	Handbrause - Platin gebürstet	28 017 979-06
---	--------------------------------------	---------------

Benötigtes Zubehör

	Handbrause FlowReduce - Platin gebürstet	28 018 979-06 0010
---	---	-----------------------

Benötigtes Zubehör

	SERIENNEUTRAL Handbrause FlowReduce - Platin gebürstet	28 029 979-06 0010
---	---	-----------------------

TARA Shower Pipe ohne Handbrause FlowReduce 220 mm - Platin gebürstet

26 633 892 Produktversion ab 4/1/2024

Durchflussdiagramm

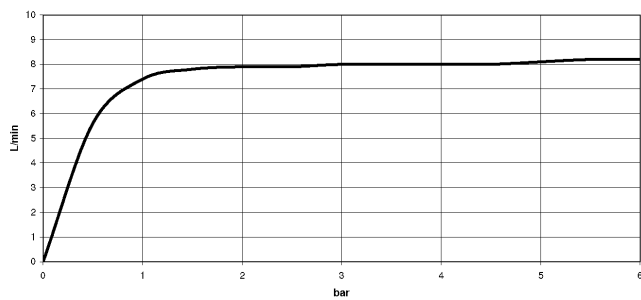

Codes & Standards

DIN 4109

EN 1717

ISO 3822

Scottish Water
Byelaws

UK Water Supply
Regulations

Ü-Zeichen



TARA Shower Pipe ohne Handbrause FlowReduce 220 mm - Platin gebürstet

26 633 892 Produktversion ab 4/1/2024

Zertifikate

Belgaqua_21-023-2 WRAS_2204

LGA_38

TARA Shower Pipe ohne Handbrause FlowReduce 220 mm - Platin gebürstet

26 633 892 Produktversion ab 4/1/2024

Ersatzteile für die
anderen
Oberflächenvarianten
finden Sie hier:
Chrom

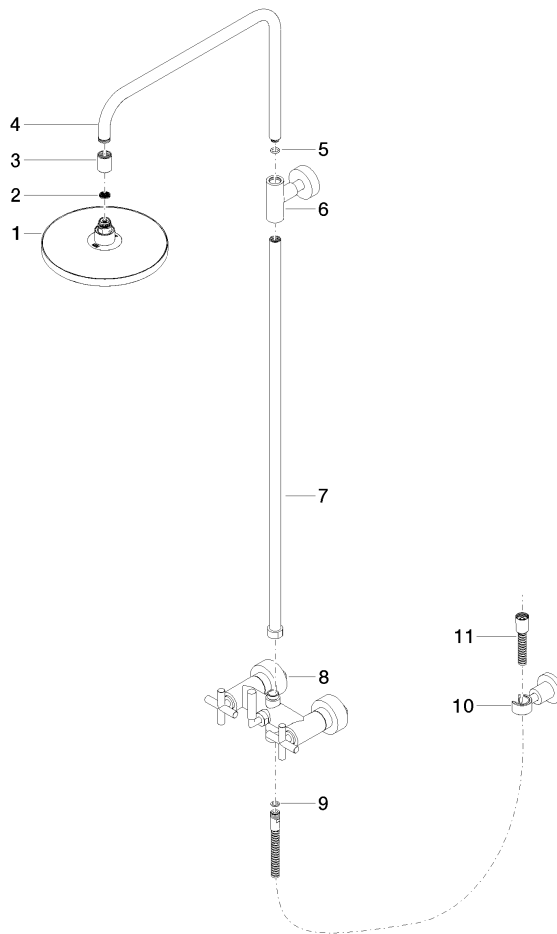

Ersatzteilstückliste

Nr.	Artikelnummer	Benennung	Verbaumenge	Lieferzeit
1	90 12 05 092 20-06	Brause	1	10
2	09 23 01 039 90	Sieb	1	2
3	09 24 03 177 20-06	Adapter	1	10
4	04 28 22 101 20-06	Auslauf	1	10
5	90 14 10 011 00 90	Dichtung	1	2
6	90 17 11 037 00-06	Halter	1	10
7	90 28 22 096 00-06	Rohr	1	10
8	04 17 10 020 01-06	Armatur	1	10
9	90 14 20 026 00 90	Dichtung	1	2
10	28 050 892-06	TARA Brausehalter - Platin gebürstet	1	10
11	28 304 970-06	Metall-Brauseschlauch 1/2" x 3/8" x 1500 mm - Platin gebürstet	1	2