

26 633 892



- Ausladung Standbrause 420 mm
- Kopfbrause: Regenstrahl
- Regenbrause Ø 220 mm
- Regenbrause mit Antikalk-System
- Durchfluss Regenbrause max. 7 l/min (bei 3 Bar)
- Drehumstellung Standbrause/ Handbrause
- Höhe Armatur bis Regenbrause (Unterkante) 1007 mm
- Höhe Armatur bis Oberkante Bogen 1167 mm
- Rosette für Brausehalter Ø 55 mm
- Rosette für Wandbefestigung Ø 57 mm
- Rosette für Brausebatterie Ø 65 mm
- Stichmaß 150 mm ± 13 mm
- Metallbrauseschlauch 1500 mm
- Anschluss 1/2"
- Rohrdurchmesser 20 mm
- mit Leerlauf-Funktion
- Dieses Produkt leistet einen Beitrag zur Erfüllung der Vorgaben von nachhaltigen Gebäudezertifizierungen, z.B. LEED®, BREEAM®, DGNB

Dieser Artikel enthält keine Handbrause!
Eigensicher gegen Rückfließen.

	Platin	26 633 892-08
	Chrom	26 633 892-00
	Platin gebürstet	26 633 892-06
	Dark Chrome	26 633 892-19
	Messing gebürstet (23kt Gold)	26 633 892-28
	Schwarz matt	26 633 892-33
	Bronze gebürstet	26 633 892-42
	Champagne gebürstet (22kt Gold)	26 633 892-46
	Champagne (22kt Gold)	26 633 892-47
	Chrom gebürstet	26 633 892-93
	Dark Platin gebürstet	26 633 892-99

26 633 892

Benötigtes Zubehör

	Handbrause - Platin	28 015 979-08
---	----------------------------	---------------

Benötigtes Zubehör

	Handbrause FlowReduce - Platin	28 012 979-08 0010
---	---------------------------------------	-----------------------

Benötigtes Zubehör

	Handbrause - Platin	28 012 979-08
---	----------------------------	---------------

Benötigtes Zubehör

	Handbrause - Platin	28 018 979-08
---	----------------------------	---------------

Benötigtes Zubehör

	SERIENNEUTRAL Handbrause - Platin	28 029 979-08 0010
---	--	-----------------------

Benötigtes Zubehör

	SERIENNEUTRAL Handbrause - Platin	28 025 979-08 0010
---	--	-----------------------

Benötigtes Zubehör

	Handbrause - Platin	28 017 979-08
---	----------------------------	---------------

Benötigtes Zubehör

	Handbrause - Platin	28 016 979-08
---	----------------------------	---------------

Benötigtes Zubehör

	Handbrause FlowReduce - Platin	28 016 979-08 0010
---	---------------------------------------	-----------------------

Benötigtes Zubehör

	Handbrause FlowReduce - Platin	28 018 979-08 0010
---	---------------------------------------	-----------------------

Benötigtes Zubehör

	SERIENNEUTRAL Handbrause - Platin	28 027 979-08 0010
---	--	-----------------------

Durchflussdiagramm

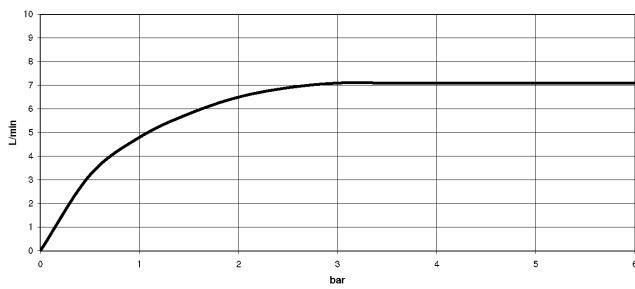

Codes & Standards

DIN 4109

EN 1717

ISO 3822

Scottish Water
Byelaws

UK Water Supply
Regulations

Ü-Zeichen



TARA Shower Pipe ohne Handbrause FlowReduce 220 mm - Platin

TARA

26 633 892

Zertifikate

Belgaqua_21-023-2 LGA_38

WRAS_2204

26 633 892

Produktversion ab 4/1/2024

Ersatzteile für die
anderen
Oberflächenvarianten
finden Sie hier:
Chrom

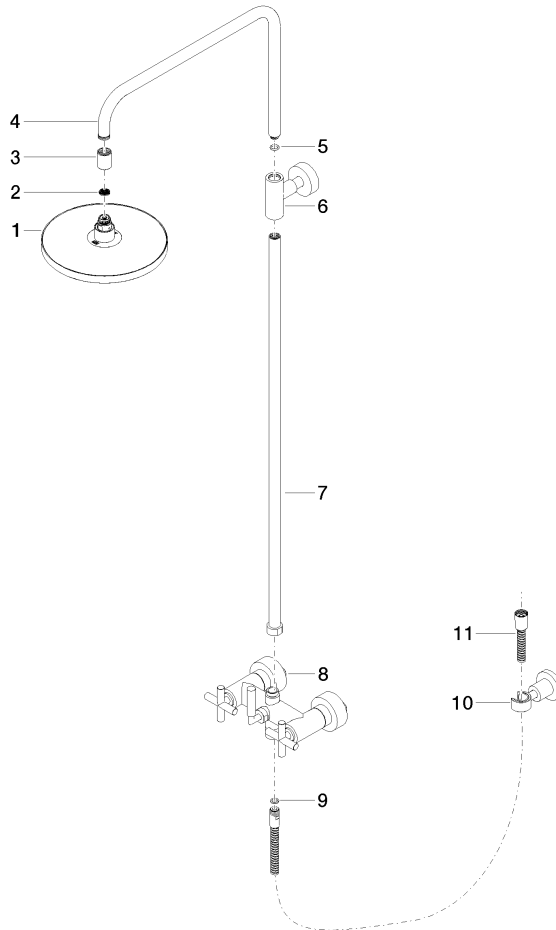



TARA Shower Pipe ohne Handbrause FlowReduce 220 mm - Platin

TARA

26 633 892

Ersatzteilstückliste

Produktversion ab 4/1/2024

Nr.	Artikelnummer	Benennung	Verbaumenge	Lieferzeit
	90 12 05 092 20-08	Brause	11	40