













28 504 979



- Ausladung 180-210 mm
- Kugelgelenk 30° schwenkbar
- PURIFY RAIN, Durchfluss max. 7 l/min (bei 3 Bar)
- Funktion ab: 6 l/min
- mit Antikalk-System
- Brausekopf Ø 100 mm
- Rosette Ø 55 mm
- Anschluss 1/2"

Passt zu: TARA, LISSÉ, VAIA, META

	Champagne (22kt Gold)	28 504 979-47
	Chrom	28 504 979-00
	Platin gebürstet	28 504 979-06
	Platin	28 504 979-08
	Dark Chrome	28 504 979-19
	Light Gold	28 504 979-26
	Light Gold gebürstet	28 504 979-27
	Messing gebürstet (23kt Gold)	28 504 979-28
	Schwarz matt	28 504 979-33
	Bronze gebürstet	28 504 979-42
	Champagne gebürstet (22kt Gold)	28 504 979-46
	Chrom gebürstet	28 504 979-93
	Dark Platinum gebürstet	28 504 979-99

Empfohlenes Zubehör

UP-Wandwinkel - 35 085 970 90



- Max. Einbautiefe 163 mm
- Min. Einbautiefe 90 mm

28 504 979

mm [inches]

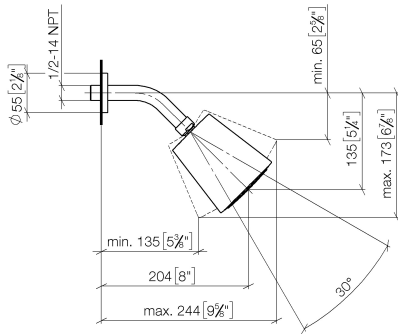

Durchflussdiagramm

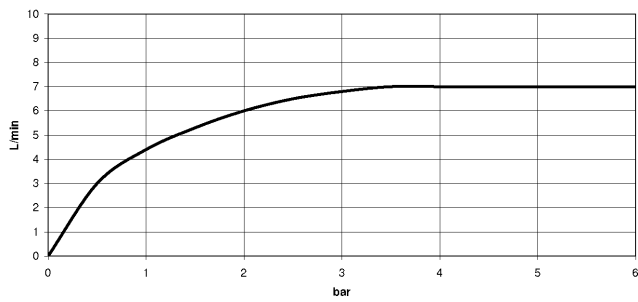

Zertifikate

DVGW_DW- LGA_19924.
6517DN0118.

28 504 979

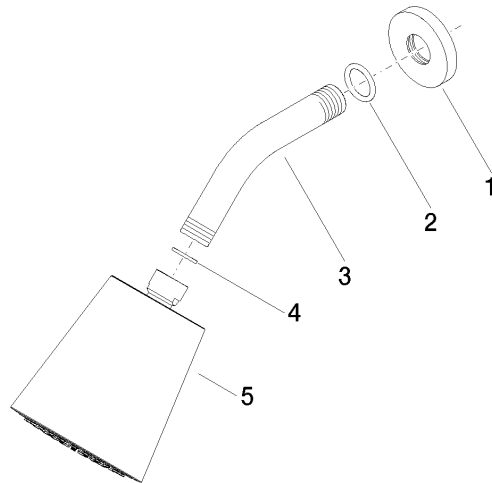

Ersatzteilstückliste

Nr.	Artikelnummer	Benennung	Verbaumenge	Lieferzeit
1	09 27 22 003-47	Rosette	1	60
2	90 14 10 026 00 90	Dichtung	1	2
3	09 11 03 011-47	Anschluss	1	30
4	90 14 20 002 00 90	Dichtung	1	2
5	90 12 05 054 00-47	Brause	1	30