













28 508 360



- Ausladung 200 mm
- Kugelgelenk 30° schwenkbar
- Dreifach verstellbar: PURIFY RAIN, COMPACT SOFT FLOW, COMPACT AQUAPRESSURE FLOW, Durchfluss max. 9 l/min (bei 3 Bar)
- Funktion ab: 7 l/min
- mit Antikalk-System
- Brausekopf Ø 94 mm
- Rosette Ø 55 mm
- Anschluss 1/2"

	Messing (23kt Gold)	28 508 360-09
	Chrom	28 508 360-00 0010
	Chrom	28 508 360-00
	Platin gebürstet	28 508 360-06 0010
	Platin gebürstet	28 508 360-06
	Platin	28 508 360-08 0010
	Platin	28 508 360-08
	Messing (23kt Gold)	28 508 360-09 0010
	Messing gebürstet (23kt Gold)	28 508 360-28 0010
	Messing gebürstet (23kt Gold)	28 508 360-28
	Dark Platinum gebürstet	28 508 360-99 0010
	Dark Platinum gebürstet	28 508 360-99

Empfohlenes Zubehör

UP-Wandwinkel -

35 085 970 90



- Max. Einbautiefe 163 mm
- Min. Einbautiefe 90 mm

28 508 360

mm [inches]

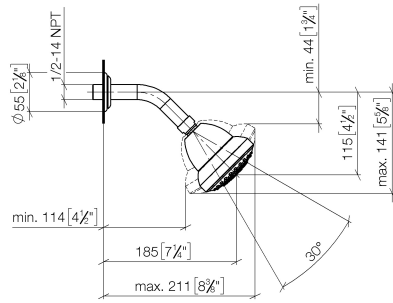

Durchflussdiagramm



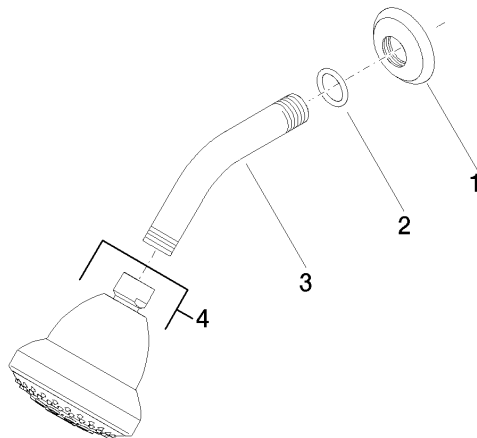

Ersatzteilstückliste

Nr.	Artikelnummer	Benennung	Verbaumenge	Lieferzeit
1	09 27 35 003-09	Rosette	1	40
2	90 14 10 026 00 90	Dichtung	1	2
3	09 11 03 011-09	Anschluss	1	60
4	04 12 11 120 00-09	Brause	1	-

Ersatzteil nicht mehr bestellbar, bitte bestellen Sie den Nachfolgeartikel