













28 679 970



- Ausladung 450 mm
- Regenbrause Ø 300 mm
- PURE RAIN, Durchfluss max. 14 l/min (bei 3 Bar)
- Funktion ab: 10 l/min
- Rosette Ø 60 mm
- Anschluss 1/2"
- mit Antikalk-System
- mit Leerlauf-Funktion

Passt zu: TARA, LISSÉ, VAIA, META

	Dark Chrome	28 679 970-19
	Chrom	28 679 970-00
	Platin gebürstet	28 679 970-06
	Platin	28 679 970-08
	Light Gold	28 679 970-26
	Light Gold gebürstet	28 679 970-27
	Messing gebürstet (23kt Gold)	28 679 970-28
	Schwarz matt	28 679 970-33
	Bronze gebürstet	28 679 970-42
	Champagne gebürstet (22kt Gold)	28 679 970-46
	Champagne (22kt Gold)	28 679 970-47
	Chrom gebürstet	28 679 970-93
	Dark Platinum gebürstet	28 679 970-99

Empfohlenes Zubehör

- UP-Wandwinkel -** 35 085 970 90
- Max. Einbautiefe 163 mm
 - Min. Einbautiefe 90 mm



28 679 970

mm [inches]

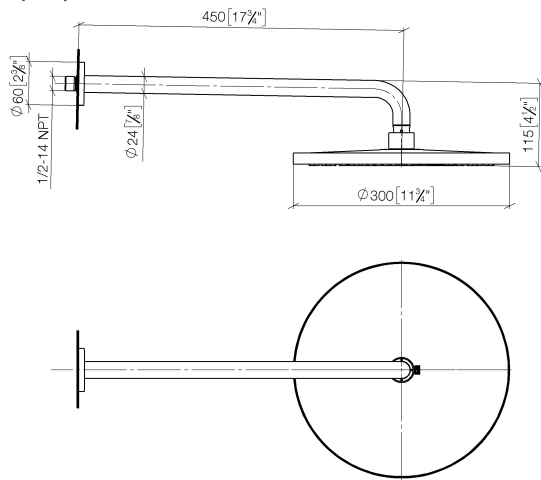

Durchflussdiagramm

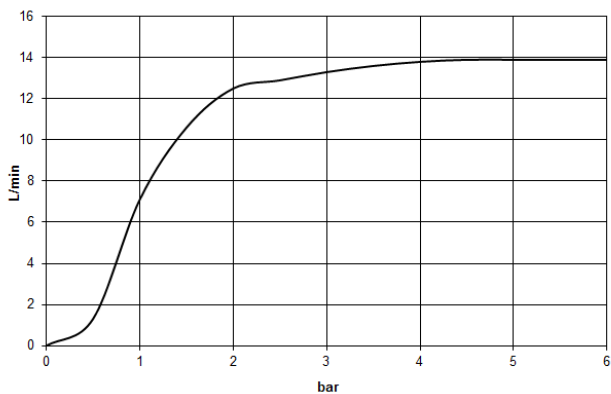

Zertifikate

WRAS_2212012.

DVGW_DW-
6517DN0118.

LGA_29235.

