











28 679 970



- Ausladung 450 mm
- Regenbrause Ø 300 mm
- PURE RAIN, Durchfluss max. 14 l/min (bei 3 Bar)
- Funktion ab: 10 l/min
- Rosette Ø 60 mm
- Anschluss 1/2"
- mit Antikalk-System
- mit Leerlauf-Funktion

Passt zu: TARA, LISSÉ, VAIA, META

	Light Gold gebürstet	28 679 970-27
	Chrom	28 679 970-00
	Platin gebürstet	28 679 970-06
	Platin	28 679 970-08
	Dark Chrome	28 679 970-19
	Light Gold	28 679 970-26
	Messing gebürstet (23kt Gold)	28 679 970-28
	Schwarz matt	28 679 970-33
	Bronze gebürstet	28 679 970-42
	Champagne gebürstet (22kt Gold)	28 679 970-46
	Champagne (22kt Gold)	28 679 970-47
	Chrom gebürstet	28 679 970-93
	Dark Platinum gebürstet	28 679 970-99

Empfohlenes Zubehör

**UP-Wandwinkel -** 35 085 970 90



- Min. Einbautiefe 90 mm
- Max. Einbautiefe 163 mm

28 679 970

mm [inches]

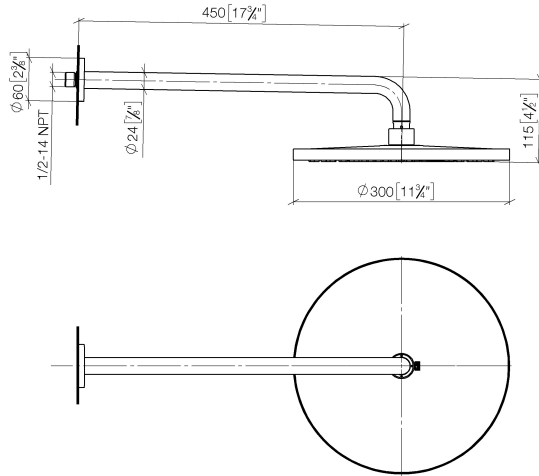

### Durchflussdiagramm

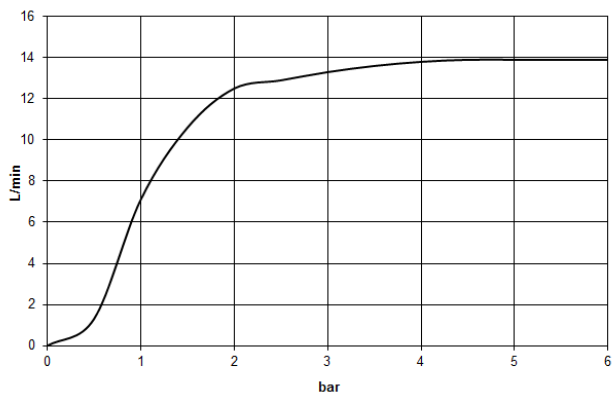

### Zertifikate

WRAS\_2212012.

DVGW\_DW-  
6517DN0118.

LGA\_29235.

28 679 970

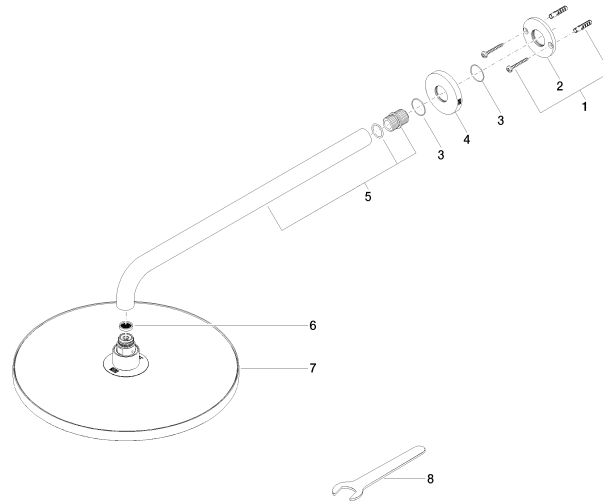

### Ersatzteilstückliste

Nr.	Artikelnummer	Benennung	Verbaumenge	Lieferzeit
1	04 30 31 032 00 90	Befestigungssatz	1	2
2	09 17 20 120 90	Halter	1	2
3	09 14 10 150 90	Dichtung	2	2
4	09 27 97 015-27	Rosette	1	60
5	90 11 03 070 00-27	Rohr	1	30
6	09 23 01 075 90	Einsatz	1	2
7	04 12 05 091 00-27	Brause	1	60
8	90 30 09 069 00 90	Schlüssel	1	2