







33 500 671



- Ausladung 125 mm
- starrer Auslauf
- rechteckiger luftangereicherter Strahl
- Armaturenhöhe 170 mm
- Höhe bis Luftsprudler 71 mm
- Bohrungsdurchmesser 35 mm
- 2x Druckschlauch M 10 x 1 eingeschraubt, dichtheitsgeprüft
- Durchfluss max. 4,6 l/min
- bleifrei
- Dieses Produkt leistet einen Beitrag zur Erfüllung der Vorgaben von nachhaltigen Gebäudezertifizierungen, z.B. LEED®, BREEAM®, DGNB

Nur für Becken mit Überlauf geeignet.

	Dark Platinum gebürstet	33 500 671-99
	Chrom	33 500 671-00
	Platin gebürstet	33 500 671-06
	Dark Chrome	33 500 671-19
	Light Gold gebürstet	33 500 671-27
	Schwarz matt	33 500 671-33
	Chrom gebürstet	33 500 671-93

33 500 671

mm [inches]

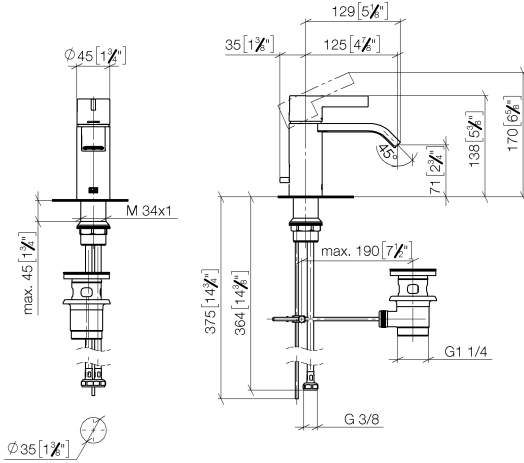

**Durchflussdiagramm**

