





33 525 660



- Ausladung 105 mm
- starrer Auslauf
- runder luftangereicherter Strahl
- Armaturenhöhe 138 mm
- Höhe bis Luftsprudler 57 mm
- Bohrungsdurchmesser 35 mm
- Rosette Ø 50 mm wahlweise
- 2x Druckschlauch M 8 x 1 eingeschraubt, dichtheitsgeprüft
- Durchfluss max. 5,7 l/min
- bleifrei
- Dieses Produkt leistet einen Beitrag zur Erfüllung der Vorgaben von nachhaltigen Gebäudezertifizierungen, z.B. LEED®, BREEAM®, DGNB

	Dunkelgrün	33 525 660-31
	Chrom	33 525 660-00
	Platin gebürstet	33 525 660-06
	Platin	33 525 660-08
	Dark Chrome	33 525 660-19
	Light Gold	33 525 660-26
	Light Gold gebürstet	33 525 660-27
	Messing gebürstet (23kt Gold)	33 525 660-28
	Rot	33 525 660-29
	Orange	33 525 660-30
	Schwarz matt	33 525 660-33
	Bronze gebürstet	33 525 660-42
	Champagne gebürstet (22kt Gold)	33 525 660-46
	Champagne (22kt Gold)	33 525 660-47
	Chrom gebürstet	33 525 660-93
	Dark Platinum gebürstet	33 525 660-99

33 525 660

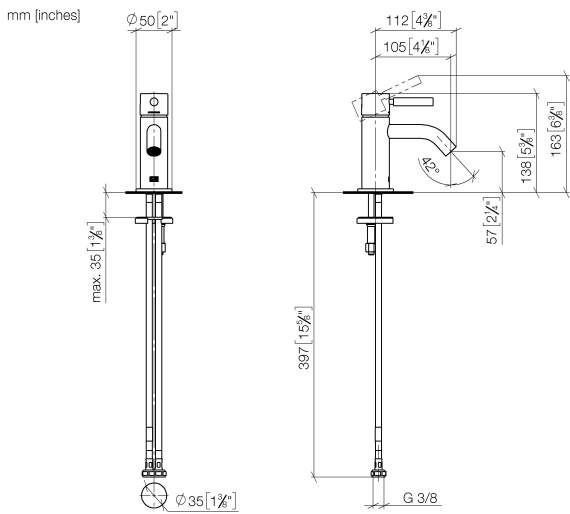

**Durchflussdiagramm**

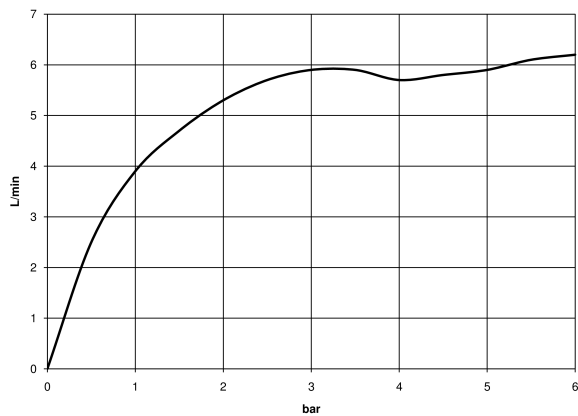

**Zertifikate**

DVGW\_DW-  
6506DN0128.

33 525 660

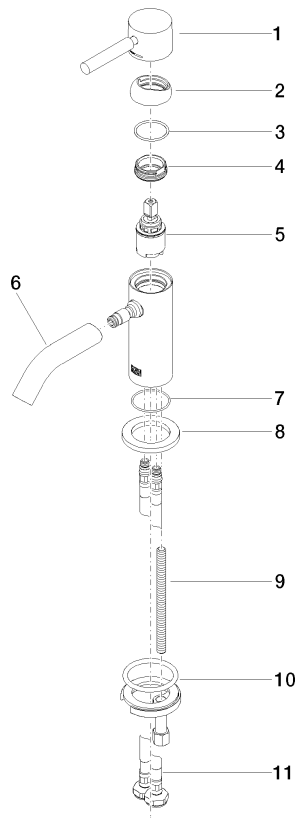

**Ersatzteilstückliste**

Nr.	Artikelnummer	Benennung	Verbaumenge	Lieferzeit
1	90 20 66 009 00-31	Griff	1	40
2	09 28 30 043-31	Haube	1	60
3	09 14 10 120 90	Dichtung	1	2
4	09 24 04 266 90	Mutter	1	2
5	90 15 05 044 00 90	Kartusche	1	2
6	90 11 06 212 00-31	Auslauf	1	40
7	09 14 10 202 90	Dichtung	1	2
8	09 27 66 006-31	Rosette	1	60
9	09 31 11 012 90	Stift	1	2
10	04 30 11 038 00 90	Befestigungssatz	1	2
11	04 30 04 100 00 90	Schlauch	2	2