











33 805 861



- Ausladung 166 mm
- schwenkbarer Auslauf 360°
- optional schwenkbegrenzbar mit Schwenkbegrenzungsset 12 820 970 90
- luftangereicherter Strahl
- Durchfluss max. 8 l/min bei 3 bar Fließdruck
- bleifrei
- Dieses Produkt leistet einen Beitrag zur Erfüllung der Vorgaben von nachhaltigen Gebäudezertifizierungen, z.B. LEED®, BREEAM®, DGNB

	Dark Platinum gebürstet	33 805 861-99
	Chrom	33 805 861-00
	Platin gebürstet	33 805 861-06
	Platin	33 805 861-08
	Messing (23kt Gold)	33 805 861-09
	Dark Chrome	33 805 861-19
	Messing gebürstet (23kt Gold)	33 805 861-28
	Schwarz matt	33 805 861-33
	Champagne gebürstet (22kt Gold)	33 805 861-46
	Champagne (22kt Gold)	33 805 861-47
	Chrom gebürstet (Edelstahl-Look)	33 805 861-93

Empfohlenes Zubehör

Schwenkbegrenzungsset - 12 820 970 90



Empfohlenes Zubehör

Spender ohne Rosette - Dark Platinum gebürstet 82 424 970-99



Empfohlenes Zubehör

Exzenterbetätigung mit Drehknopf - Dark Platinum gebürstet 10 712 970-99



33 805 861

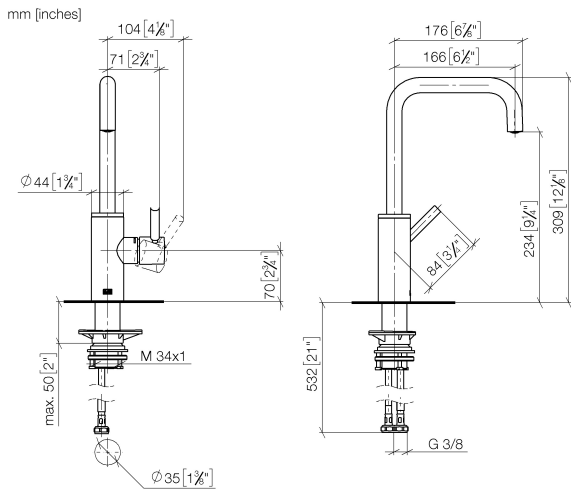

Durchflussdiagramm

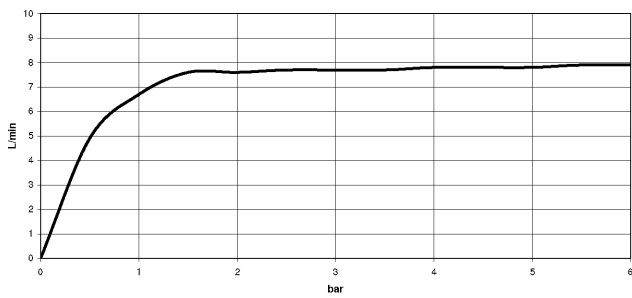

Codes & Standards

DIN 4109

ISO 3822

Scottish Water
Byelaws

UK Water Supply
Regulations

Ü-Zeichen



META SQUARE BAR TAP Einhebelmischer - Dark Platinum gebürstet

META SQUARE

33 805 861

Zertifikate

LGA_38

WRAS_240102

33 805 861

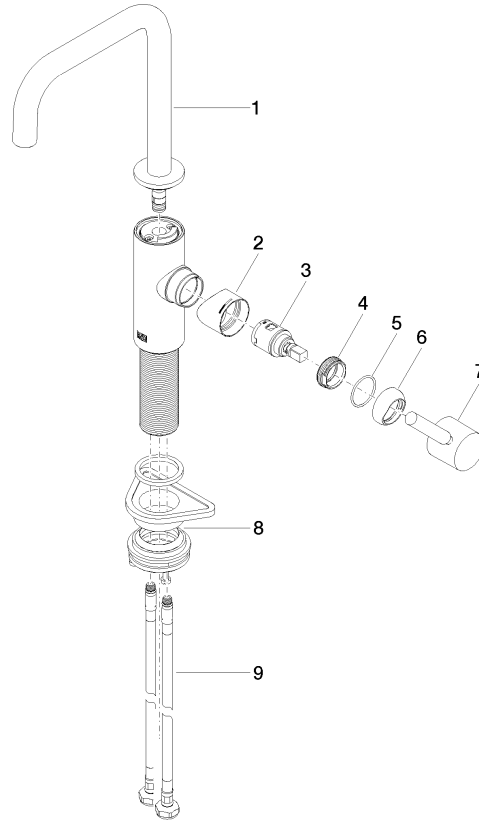



33 805 861

Ersatzteilstückliste

Nr.	Artikelnummer	Benennung	Verbaumenge	Lieferzeit
	90 28 22 285 00-99	Auslauf	10	-

Ersatzteil nicht mehr bestellbar, bitte bestellen Sie den Nachfolgeartikel