











33 805 875



- Ausladung 166 mm
- schwenkbarer Auslauf 360°
- Laminarstrahl
- Armaturenhöhe 303 mm
- Höhe bis Laminarstrahlregler 186 mm
- Bohrungsdurchmesser 35 mm
- Durchfluss max. 8 l/min bei 3 bar Fließdruck
- bleifrei
- Dieses Produkt leistet einen Beitrag zur Erfüllung der Vorgaben von nachhaltigen Gebäudezertifizierungen, z.B. LEED®, BREEAM®, DGNB

	Messing (23kt Gold)	33 805 875-09
	Chrom	33 805 875-00
	Platin gebürstet	33 805 875-06
	Platin	33 805 875-08
	Dark Chrome	33 805 875-19
	Messing gebürstet (23kt Gold)	33 805 875-28
	Schwarz matt	33 805 875-33
	Champagne gebürstet (22kt Gold)	33 805 875-46
	Champagne (22kt Gold)	33 805 875-47
	Chrom gebürstet (Edelstahl-Look)	33 805 875-93
	Dark Platinum gebürstet	33 805 875-99

Empfohlenes Zubehör

Spender ohne Rosette - Messing (23kt Gold) 82 424 970-09



Empfohlenes Zubehör

Exzenterbetätigung mit Drehknopf - Messing (23kt Gold) 10 712 970-09



33 805 875

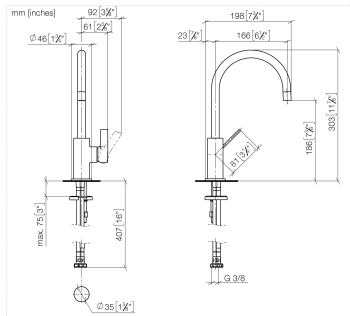

Durchflussdiagramm



Zertifikate

LGA_18899.

33 805 875

Ersatzteile für die
anderen
Oberflächenvarianten
finden Sie hier:
Chrom

