











33 815 861



- Ausladung 235 mm
- schwenkbarer Auslauf 360°
- optional schwenkbegrenzbar mit Schwenkbegrenzungsset 12 820 970 90
- luftangereicherter Strahl
- Durchfluss max. 8 l/min bei 3 bar Fließdruck
- bleifrei
- Dieses Produkt leistet einen Beitrag zur Erfüllung der Vorgaben von nachhaltigen Gebäudezertifizierungen, z.B. LEED®, BREEAM®, DGNB
- -

	Platin gebürstet	33 815 861-06
	Chrom	33 815 861-00
	Platin	33 815 861-08
	Messing (23kt Gold)	33 815 861-09
	Dark Chrome	33 815 861-19
	Messing gebürstet (23kt Gold)	33 815 861-28
	Schwarz matt	33 815 861-33
	Champagne gebürstet (22kt Gold)	33 815 861-46
	Champagne (22kt Gold)	33 815 861-47
	Chrom gebürstet (Edelstahl-Look)	33 815 861-93
	Dark Platinum gebürstet	33 815 861-99

**Empfohlenes Zubehör**

**Schwenkbegrenzungsset -** 12 820 970 90



**Empfohlenes Zubehör**

**Spender ohne Rosette - Platin gebürstet** 82 424 970-06



**Empfohlenes Zubehör**

**Exzenterbetätigung mit Drehknopf - Platin gebürstet** 10 712 970-06



33 815 861

mm [inches]

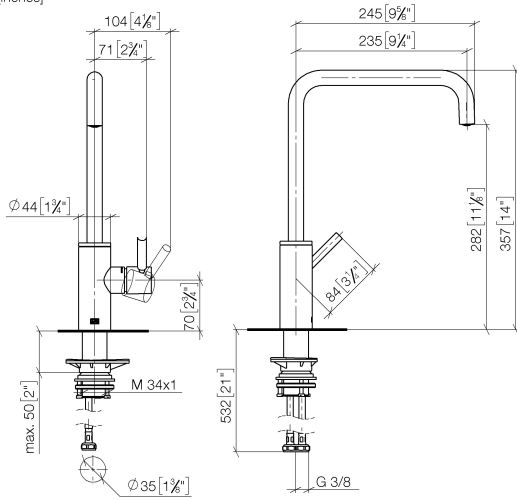

**Durchflussdiagramm**

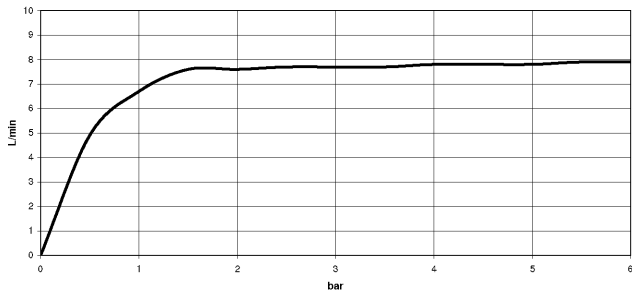

**Codes & Standards**

DIN 4109

ISO 3822

Scottish Water  
Byelaws

UK Water Supply  
Regulations

**Ü-Zeichen**



**META SQUARE Einhebelmischer - Platin gebürstet**

META SQUARE

33 815 861

Zertifikate

LGA\_38

WRAS\_240102

33 815 861

Produktversion ab 2/1/2023

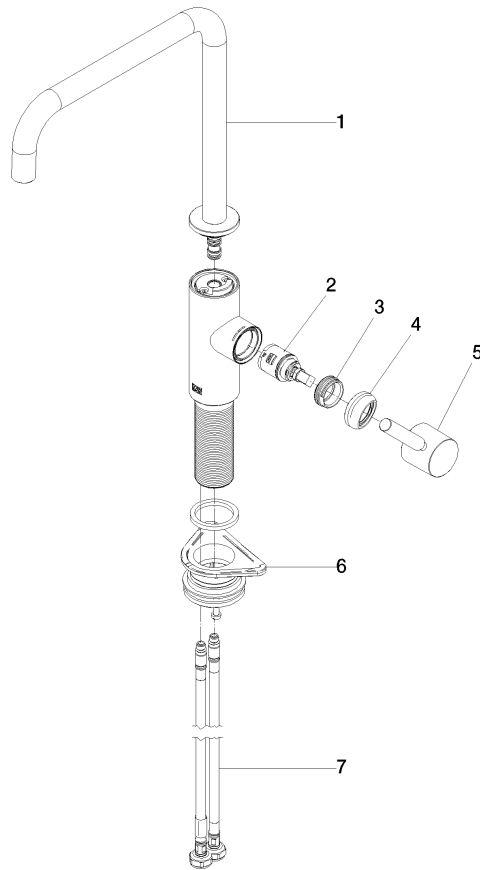



33 815 861

### Ersatzteilstückliste

#### Produktversion ab 2/1/2023

Nr.	Artikelnummer	Benennung	Verbaumenge	Lieferzeit
	90 28 22 284 00-06	Auslauf	8	10