











33 870 861



- Ausladung 240 mm
- schwenkbarer Auslauf 360°
- optional schwenkbegrenzbar mit Schwenkbegrenzungsset 12 823 970 90
- Laminar- und Brausestrahl
- Metallbrauseschlauch 1800 mm
- Sprayface mit Antikalk-System
- Durchfluss max. 10,4 l/min bei 3 bar Fließdruck
- bleifrei
- Dieses Produkt leistet einen Beitrag zur Erfüllung der Vorgaben von nachhaltigen Gebäudezertifizierungen, z.B. LEED®, BREEAM®, DGNB

Eigensicher gegen Rückfließen.

	Platin	33 870 861-08
	Chrom	33 870 861-00
	Platin gebürstet	33 870 861-06
	Messing (23kt Gold)	33 870 861-09
	Dark Chrome	33 870 861-19
	Messing gebürstet (23kt Gold)	33 870 861-28
	Schwarz matt	33 870 861-33
	Champagne gebürstet (22kt Gold)	33 870 861-46
	Champagne (22kt Gold)	33 870 861-47
	Chrom gebürstet (Edelstahl-Look)	33 870 861-93
	Dark Platin gebürstet	33 870 861-99

Empfohlenes Zubehör

	Schwenkbegrenzungsset -	12 823 970 90
---	--------------------------------	---------------

Empfohlenes Zubehör

	Spender ohne Rosette - Platin	82 424 970-08
---	--------------------------------------	---------------

Empfohlenes Zubehör

	Exzenterbetätigung mit Drehknopf - Platin	10 712 970-08
---	--	---------------

33 870 861

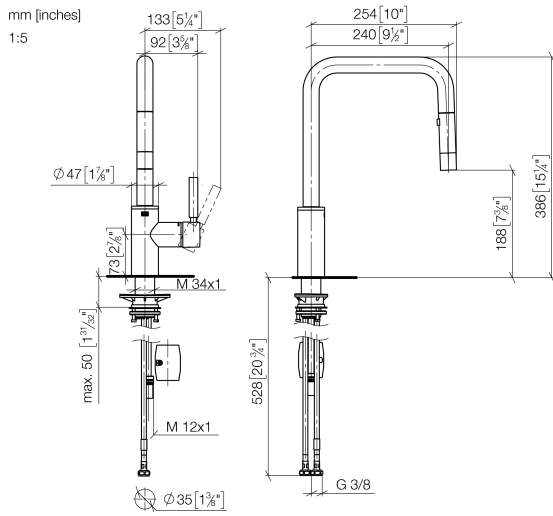

Durchflussdiagramm

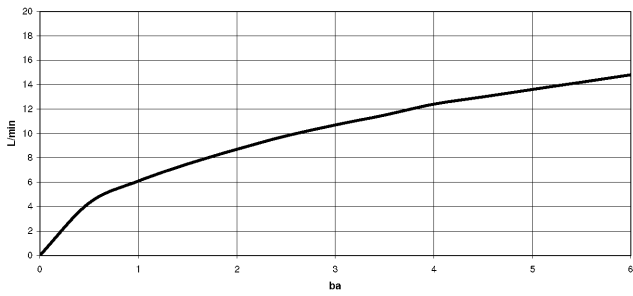

Codes & Standards

DIN 4109

EN 1717

ISO 3822

Ü-Zeichen



META SQUARE Einhebelmischer Pull-down mit Brausefunktion - Platin

META SQUARE

33 870 861

Zertifikate

Belgaqua_24-005-2 LGA_38

33 870 861

Produktversion ab 2/1/2023

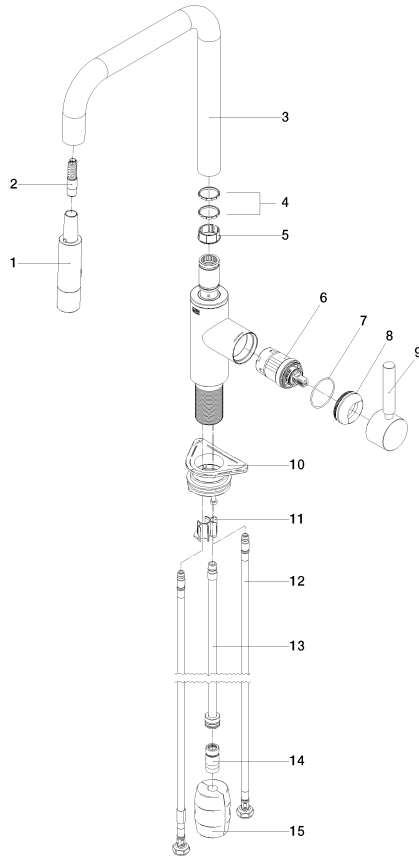



33 870 861

Ersatzteilstückliste

Produktversion ab 2/1/2023

Nr.	Artikelnummer	Benennung	Verbaumenge	Lieferzeit
	90 12 11 148 00-08	Brause	17	40