







33 870 875



- Ausladung 240 mm
- schwenkbarer Auslauf 360°
- optional schwenkbegrenzbar mit Schwenkbegrenzungsset 12 823 970 90
- Laminar- und Brausestrahl
- Armaturenhöhe 500 mm
- Höhe bis Laminarstrahlregler 240 mm
- Bohrungsdurchmesser 35 mm
- Metallbrauseschlauch 1800 mm
- Sprayface mit Antikalk-System
- Durchfluss max. 10,4 l/min bei 3 bar Fließdruck
- bleifrei
- Dieses Produkt leistet einen Beitrag zur Erfüllung der Vorgaben von nachhaltigen Gebäudezertifizierungen, z.B. LEED®, BREEAM®, DGNB

Eigensicher gegen Rückfließen.

	Dark Chrome	33 870 875-19
	Chrom	33 870 875-00
	Platin gebürstet	33 870 875-06
	Platin	33 870 875-08
	Messing (23kt Gold)	33 870 875-09
	Messing gebürstet (23kt Gold)	33 870 875-28
	Schwarz matt	33 870 875-33
	Champagne gebürstet (22kt Gold)	33 870 875-46
	Champagne (22kt Gold)	33 870 875-47
	Chrom gebürstet (Edelstahl-Look)	33 870 875-93
	Dark Platinum gebürstet	33 870 875-99

Empfohlenes Zubehör

	Schwenkbegrenzungsset -	12 823 970 90
---	--------------------------------	---------------

Empfohlenes Zubehör

	Exzenterbetätigung mit Drehknopf - Dark Chrome	10 712 970-19
---	---	---------------

Empfohlenes Zubehör

	Spender ohne Rosette - Dark Chrome	82 424 970-19
---	---	---------------

33 870 875

mm [inches]

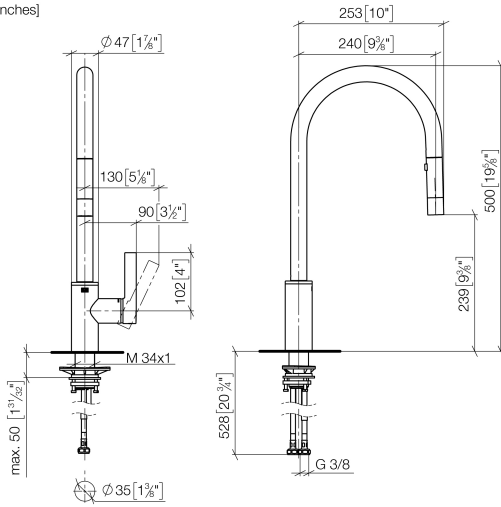

Durchflussdiagramm

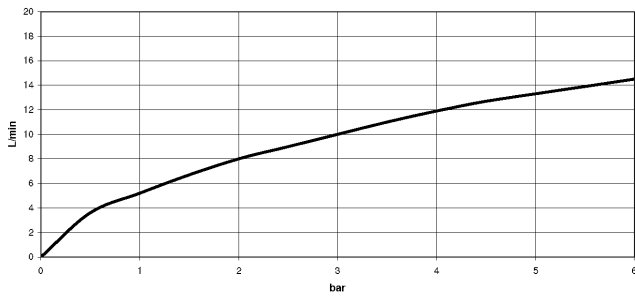

Codes & Standards

DIN 4109

EnergieEtikette B

Executive Order
no. 1007

ISO 3822

Ü-Zeichen



TARA ULTRA Einhebelmischer Pull-down mit Brausefunktion - Dark Chrome

TARA ULTRA

33 870 875

Zertifikate

LGA_28

GDV_0400

33 870 875

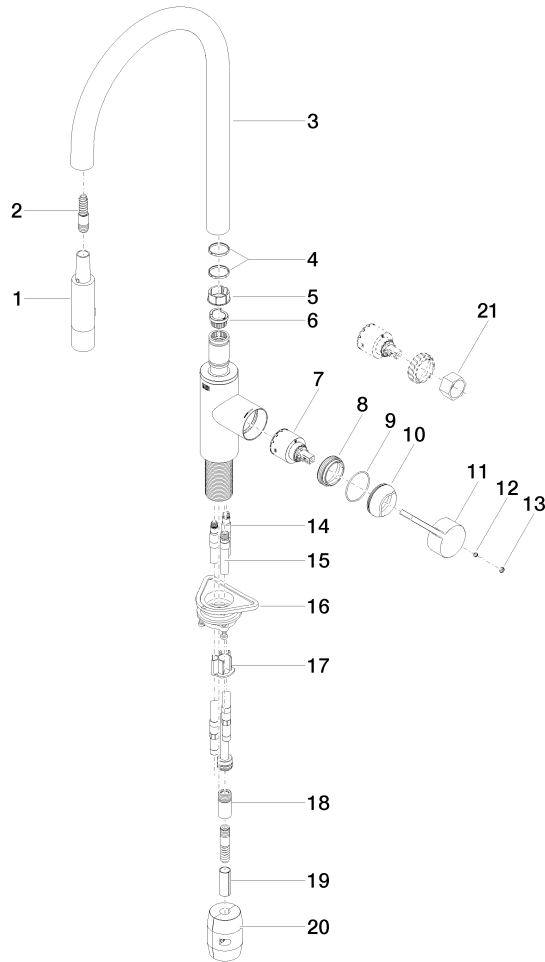



Ersatzteilstückliste