











33 875 895



- Ausladung 240 mm
- schwenkbarer Auslauf 360°
- optional schwenkbegrenzbar mit Schwenkbegrenzungsset 12 821 970 90
- Laminar- und Brausestrahl
- Armaturenhöhe 420 mm
- Höhe bis Laminarstrahlregler 240 mm
- Bohrungsdurchmesser 35 mm
- Metallbrauseschlauch 1800 mm
- Sprayface mit Antikalk-System
- Durchfluss max. 10,4 l/min bei 3 bar Fließdruck
- bleifrei
- Dieses Produkt leistet einen Beitrag zur Erfüllung der Vorgaben von nachhaltigen Gebäudezertifizierungen, z.B. LEED®, BREEAM®, DGNB

Eigensicher gegen Rückfließen.

| | | |
|--|----------------------------------|---------------|
|  | Dark Chrome | 33 875 895-19 |
|  | Chrom | 33 875 895-00 |
|  | Platin gebürstet | 33 875 895-06 |
|  | Platin | 33 875 895-08 |
|  | Messing (23kt Gold) | 33 875 895-09 |
|  | Messing gebürstet (23kt Gold) | 33 875 895-28 |
|  | Schwarz matt | 33 875 895-33 |
|  | Champagne gebürstet (22kt Gold) | 33 875 895-46 |
|  | Champagne (22kt Gold) | 33 875 895-47 |
|  | Chrom gebürstet (Edelstahl-Look) | 33 875 895-93 |
|  | Dark Platinum gebürstet | 33 875 895-99 |

Empfohlenes Zubehör

Schwenkbegrenzungsset - 12 821 970 90



Empfohlenes Zubehör

Exzenterbetätigung mit Drehknopf - Dark Chrome 10 712 970-19



Empfohlenes Zubehör

Spender ohne Rosette - Dark Chrome 82 424 970-19



33 875 895

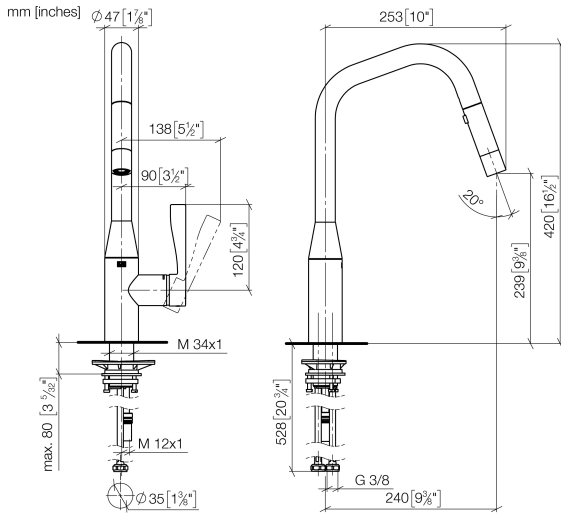

Durchflussdiagramm

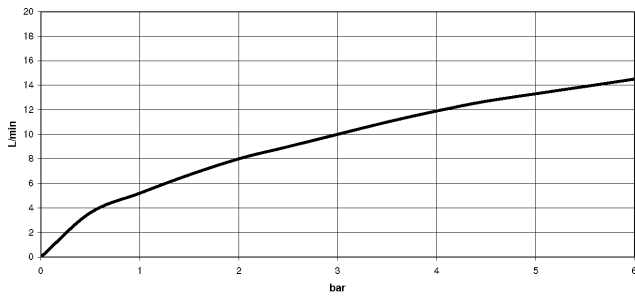

Codes & Standards

EnergieEtikette B

Executive Order
no. 1007



SYNC Einhebelmischer Pull-down mit Brausefunktion - Dark Chrome

SYNC

33 875 895

Zertifikate

GDV_0400

33 875 895

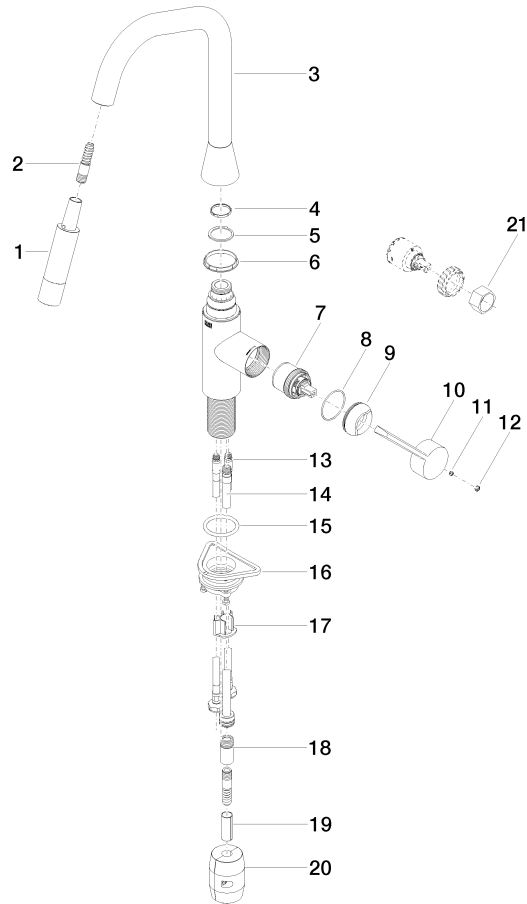



Ersatzteilstückliste