

**TARA Showerpipe mit Brause-Thermostat ohne Handbrause FlowReduce 220 mm - Chrom**

TARA

34 458 892



- Ausladung Standbrause 452 mm
  - Regenbrause: PURE RAIN, Durchfluss max. 7 l/min (bei 3 Bar)
  - Funktion ab: 6 l/min
  - Regenbrause Ø 220 mm
  - Regenbrause mit Antikalk-System
  - Drehumstellung mit Mengenregulierung und Absperrfunktion
  - Schubrosetten Ø 70 mm
  - Höhe Armatur bis Regenbrause (Unterkante) 964 mm
  - Höhe Armatur bis Oberkante Bogen 1267 mm
  - Stichmaß 150 mm ± 13 mm
  - Metallbrauseschlauch 1750 mm mit integriertem Verdrehschutz
  - Anschluss 1/2"
  - Wandrohr mit Schieber
  - Rohrdurchmesser 23,5 mm
  - Dieses Produkt leistet einen Beitrag zur Erfüllung der Vorgaben von nachhaltigen Gebäudezertifizierungen, z.B. LEED®, BREEAM®, DGNB
- Dieser Artikel enthält keine Handbrause!**  
**Eigensicher gegen Rückfließen.**

Dieser Artikel enthält keine Handbrause!

Eigensicher gegen Rückfließen.

	Chrom	34 458 892-00
	Platin gebürstet	34 458 892-06
	Platin	34 458 892-08
	Dark Chrome	34 458 892-19
	Messing gebürstet (23kt Gold)	34 458 892-28
	Schwarz matt	34 458 892-33
	Bronze gebürstet	34 458 892-42
	Champagne gebürstet (22kt Gold)	34 458 892-46
	Champagne (22kt Gold)	34 458 892-47
	Chrom gebürstet	34 458 892-93
	Dark Platinum gebürstet	34 458 892-99

TARA Showerpipe mit Brause-Thermostat ohne Handbrause FlowReduce 220 mm - Chrom

TARA

34 458 892

Benötigtes Zubehör

	<b>Handbrause - Chrom</b>	28 016 979-00
---	---------------------------	---------------

Benötigtes Zubehör

	<b>Handbrause - Chrom</b>	28 012 979-00
---	---------------------------	---------------

Benötigtes Zubehör

	<b>Handbrause FlowReduce - Chrom</b>	28 016 979-00 0010
---	--------------------------------------	-----------------------

Benötigtes Zubehör

	<b>Handbrause FlowReduce - Chrom</b>	28 012 979-00 0010
---	--------------------------------------	-----------------------

Benötigtes Zubehör

	<b>Handbrause FlowReduce - Chrom</b>	28 018 979-00 0010
---	--------------------------------------	-----------------------

Benötigtes Zubehör

	<b>SERIENNEUTRAL Handbrause - Chrom</b>	28 029 979-00
---	---	---------------

Benötigtes Zubehör

	<b>SERIENNEUTRAL Handbrause - Chrom</b>	28 029 979-00 0010
---	---	-----------------------

Benötigtes Zubehör

	<b>SERIENNEUTRAL Handbrause - Chrom</b>	28 025 979-00 0010
---	---	-----------------------

Benötigtes Zubehör

	<b>Handbrause - Chrom</b>	28 016 979-00
---	---------------------------	---------------

Benötigtes Zubehör

	<b>Handbrause FlowReduce - Chrom</b>	28 016 979-00 0010
---	--------------------------------------	-----------------------

Benötigtes Zubehör

	<b>Handbrause - Chrom</b>	28 017 979-00
---	---------------------------	---------------

Benötigtes Zubehör

	<b>Handbrause - Chrom</b>	28 018 979-00
---	---------------------------	---------------

Benötigtes Zubehör

	<b>SERIENNEUTRAL Handbrause - Chrom</b>	28 029 979-00
---	---	---------------

Benötigtes Zubehör

	<b>SERIENNEUTRAL Handbrause - Chrom</b>	28 029 979-00 0010
---	---	-----------------------

Benötigtes Zubehör

	<b>SERIENNEUTRAL Handbrause - Chrom</b>	28 027 979-00 0010
---	---	-----------------------

34 458 892  
mm [inches]  
1:10

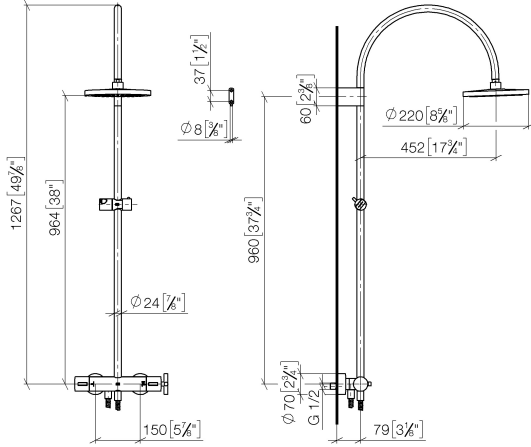

**Durchflussdiagramm**

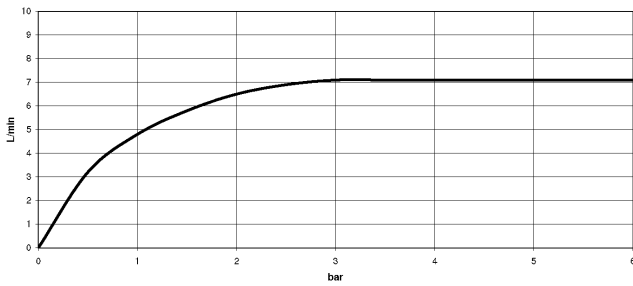

**Codes & Standards**

DIN 4109

EN 1717

ISO 3822

Scottish Water  
Byelaws

UK Water Supply  
Regulations

Ü-Zeichen



TARA Showerpipe mit Brause-Thermostat ohne Handbrause FlowReduce 220  
mm - Chrom

---

TARA

34 458 892

Zertifikate

---

WRAS\_2204

LGA\_38

Belgaqua\_22\_283\_2

34 458 892

Produktversion ab 5/1/2022

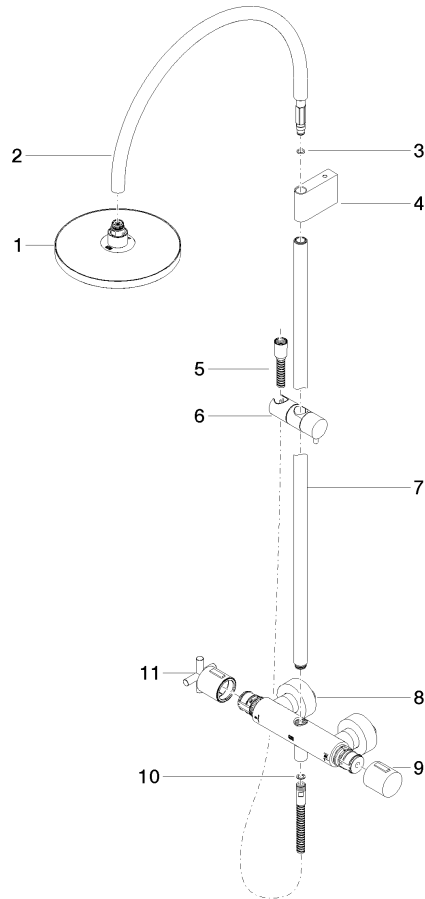



TARA Showerpipe mit Brause-Thermostat ohne Handbrause FlowReduce 220  
mm - Chrom

TARA

34 458 892

## Ersatzteilstückliste

Produktversion ab 5/1/2022

Nr.	Artikelnummer	Benennung	Verbaumenge	Lieferzeit
	90 12 05 092 20-00	Brause	11	10