

UP-Einhandbatterie mit integriertem Brauseanschluss mit Handbrausegarnitur ohne Handbrause - Schwarz matt

IMO

36 002 970



- Metallbrauseschlauch 1750 mm mit integriertem Verdreherschutz
- Dieser Artikel enthält keine Handbrause!**
- Eigensicher gegen Rückfließen.**

Dieser Artikel enthält keine Handbrause!
Eigensicher gegen Rückfließen.

Passt zu: IMO, LULU, MADISON, MEM, TARA, CL.1, LISSÉ, VAIA, META, CYO

	Schwarz matt	36 002 970-33
	Chrom	36 002 970-00
	Platin gebürstet	36 002 970-06
	Platin	36 002 970-08
	Dark Chrome	36 002 970-19
	Light Gold gebürstet	36 002 970-27
	Messing gebürstet (23kt Gold)	36 002 970-28
	Bronze gebürstet	36 002 970-42
	Champagne gebürstet (22kt Gold)	36 002 970-46
	Champagne (22kt Gold)	36 002 970-47
	Chrom gebürstet	36 002 970-93
	Dark Platin gebürstet	36 002 970-99

Benötigtes Zubehör

	UP-Wandbefestigung - •Max. Einbautiefe 105 mm •Min. Einbautiefe 80 mm	35 050 970 90
---	--	---------------

Benötigtes Zubehör

	Handbrause - Schwarz matt	28 017 979-33
---	----------------------------------	---------------

Benötigtes Zubehör

	Handbrause - Schwarz matt	28 016 979-33
---	----------------------------------	---------------

Benötigtes Zubehör

	Handbrause - Schwarz matt	28 018 979-33
---	----------------------------------	---------------

Benötigtes Zubehör

	Handbrause FlowReduce - Schwarz matt	28 016 979-33 0010
---	---	-----------------------

Benötigtes Zubehör

	Handbrause FlowReduce - Schwarz matt	28 012 979-33 0010
---	---	-----------------------

Benötigtes Zubehör

	Handbrause - Schwarz matt	28 012 979-33
---	----------------------------------	---------------

Benötigtes Zubehör

	Handbrause FlowReduce - Schwarz matt	28 018 979-33 0010
---	---	-----------------------

**UP-Einhandbatterie mit integriertem Brauseanschluss mit Handbrausegarnitur
ohne Handbrause - Schwarz matt**

IMO

36 002 970
mm [inches]

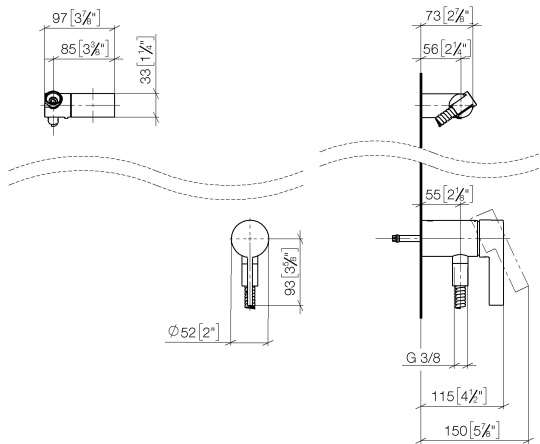

Zertifikate

Belgaqua_21-025- WRAS_2011027. LGA_29928.
27_1.

36 002 970



Ersatzteilstückliste

Nr.	Artikelnummer	Benennung	Verbaumenge	Lieferzeit
1	28 060 970-33	Brausehalter schwenkbar - Schwarz matt	1	30
2	28 322 970-33	Metall-Brauseschlauch 1/2" x 3/8" x 1750 mm - Schwarz matt	1	2
3	36 050 970-33	UP-Einhandbatterie mit integriertem Brauseanschluss - Schwarz matt	1	30