







36 060 845

- Abdeckplatte 78 x 78 mm



	Dark Platinum gebürstet	36 060 845-99
	Chrom	36 060 845-00
	Platin gebürstet	36 060 845-06
	Dark Chrome	36 060 845-19
	Schwarz matt	36 060 845-33
	Chrom gebürstet	36 060 845-93

**Benötigtes Zubehör**



- UP-Wand-Einhandbatterie -** 35 860 970 90
- Min. Einbautiefe 80 mm
  - Max. Einbautiefe 95 mm



36 060 845

Zertifikate

---

LGA\_29905.

36 060 845

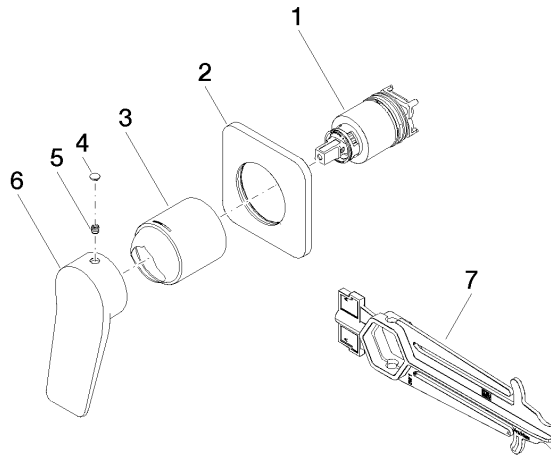

### Ersatzteilstückliste

Nr.	Artikelnummer	Benennung	Verbaumenge	Lieferzeit
1	90 15 05 046 02 90	Kartusche	1	2
2	90 27 84 020 00-99	Rosette	1	30
3	09 11 02 288-99	Haube	1	30
4	90 31 20 087 00-99	Stopfen	1	30
5	90 31 11 030 00 90	Stift	1	2
6	09 20 84 021-99	Griff	1	60
7	90 30 09 064 00 90	Schlüssel	1	2