

36 112 970



Passt zu: IMO, LULU, TARA, LISSÉ, VAIA, META

- Ausladung Standbrause 450 mm
- Kopfbrause: Regenstrahl
- Regenbrause Ø 220 mm
- Regenbrause mit Antikalk-System
- Durchfluss Regenbrause max. 14 l/min (bei 3 Bar)
- Höhe Armatur bis Regenbrause (Unterkante) 1010 mm
- Höhe Armatur bis Oberkante Bogen 1150 mm
- Metallbrauseschlauch 1750 mm mit integriertem Verdrehschutz
- Anschluss 1/2"
- Wandrohr mit Schieber
- Rohrdurchmesser 23,5 mm
- automatische Umstellung Standbrause/ Handbrause
- mit Leerlauf-Funktion

**Dieser Artikel enthält keine Handbrause!**

**Eigensicher gegen Rückfließen.**

Dieser Artikel enthält keine Handbrause!

Eigensicher gegen Rückfließen.

	Platin gebürstet	36 112 970-06
	Chrom	36 112 970-00
	Platin	36 112 970-08
	Dark Chrome	36 112 970-19
	Light Gold gebürstet	36 112 970-27
	Messing gebürstet (23kt Gold)	36 112 970-28
	Schwarz matt	36 112 970-33
	Bronze gebürstet	36 112 970-42
	Champagne gebürstet (22kt Gold)	36 112 970-46
	Champagne (22kt Gold)	36 112 970-47
	Chrom gebürstet	36 112 970-93
	Dark Platinum gebürstet	36 112 970-99

36 112 970

## Benötigtes Zubehör

	<b>UP-Wandbefestigung -</b> •Max. Einbautiefe 105 mm •Min. Einbautiefe 80 mm	35 050 970 90
---	--	---------------

## Benötigtes Zubehör

	<b>Handbrause - Platin gebürstet</b>	28 012 979-06
---	--------------------------------------	---------------

## Benötigtes Zubehör

	<b>Handbrause FlowReduce - Platin gebürstet</b>	28 012 979-06 0010
---	---	--------------------

## Benötigtes Zubehör

	<b>Handbrause - Platin gebürstet</b>	28 018 979-06
---	--------------------------------------	---------------

## Benötigtes Zubehör

	<b>SERIENNEUTRAL Handbrause - Platin gebürstet</b>	28 029 979-06 0010
---	--	--------------------

## Benötigtes Zubehör

	<b>SERIENNEUTRAL Handbrause - Platin gebürstet</b>	28 027 979-06 0010
---	--	--------------------

## Benötigtes Zubehör

	<b>Handbrause - Platin gebürstet</b>	28 016 979-06
---	--------------------------------------	---------------

## Benötigtes Zubehör

	<b>Handbrause FlowReduce - Platin gebürstet</b>	28 016 979-06 0010
---	---	--------------------

## Benötigtes Zubehör

	<b>Handbrause - Platin gebürstet</b>	28 017 979-06
---	--------------------------------------	---------------

## Benötigtes Zubehör

	<b>Handbrause FlowReduce - Platin gebürstet</b>	28 018 979-06 0010
---	---	--------------------

## Benötigtes Zubehör

	<b>SERIENNEUTRAL Handbrause - Platin gebürstet</b>	28 029 979-06
---	--	---------------

## Benötigtes Zubehör

	<b>SERIENNEUTRAL Handbrause - Platin gebürstet</b>	28 025 979-06 0010
---	--	--------------------

36 112 970

mm [inches]  
1:10

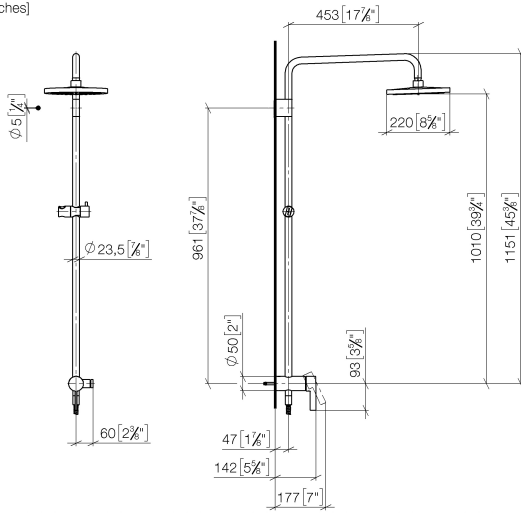

Durchflussdiagramm

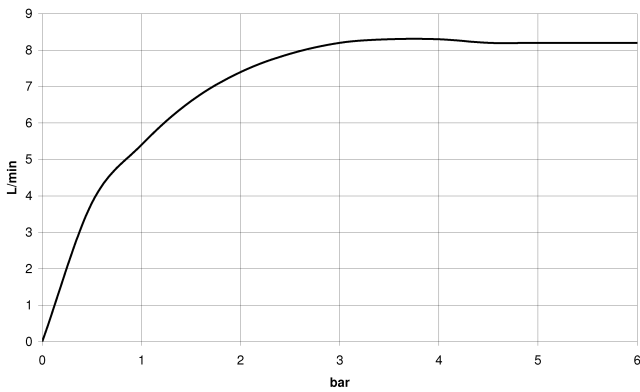

Codes & Standards

DIN 4109

EN 1717

EN 817

ISO 3822

Scottish Water  
Byelaws

UK Water Supply  
Regulations

Ü-Zeichen



# Shower Pipe mit Brause-Einhandbatterie ohne Handbrause - Platin gebürstet

IMO

36 112 970

## Zertifikate

---

DVGW\_DW-  
6512DN0

Belgaqua\_21-025-2 LGA\_38

WRAS\_2101

36 112 970

Produktversion ab 4/1/2024





# Shower Pipe mit Brause-Einhandbatterie ohne Handbrause - Platin gebürstet

IMO

36 112 970

## Ersatzteilstückliste

### Produktversion ab 4/1/2024

Nr.	Artikelnummer	Benennung	Verbaumenge	Lieferzeit
	04 12 05 092 00-06	Brause	9	10