







36 200 705

- Drehumstellung
- Rosette 60 x 60 mm



	Platin gebürstet	36 200 705-06
	Chrom	36 200 705-00
	Dark Chrome	36 200 705-19
	Champagne gebürstet (22kt Gold)	36 200 705-46
	Champagne (22kt Gold)	36 200 705-47
	Dark Platinum gebürstet	36 200 705-99

**Benötigtes Zubehör**

	<b>UP-Zweiwege-Umstellung -</b> •Max. Einbautiefe 160 mm •Min. Einbautiefe 115 mm	35 202 970 90
---	---	---------------

36 200 705

mm [inches]

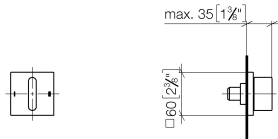

### Durchflussdiagramm



### Zertifikate

LGA\_38379.

WRAS\_2307045.

36 200 705

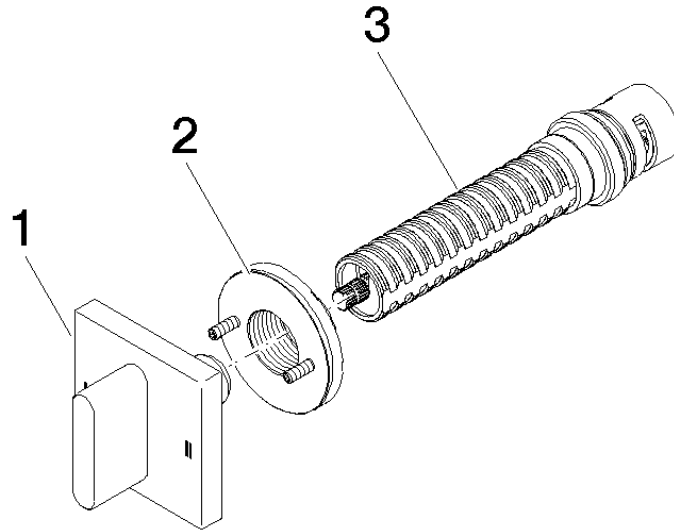

### Ersatzteilstückliste

Nr.	Artikelnummer	Benennung	Verbaumenge	Lieferzeit
1	90 20 70 051 08-06	Griff	1	10
2	90 21 02 181 00 90	Scheibe	1	2
3	90 90 03 304 10 90	Umstellung	1	2