

UP-Dreiwege-Umstellung - Light Gold gebürstet









CL.1

36 210 740



- Drehumstellung
- ohne Rosette
- Griff Ø 60 mm

Passt zu: CL.1, META, CYO

	Light Gold gebürstet	36 210 740-27
	Chrom	36 210 740-00
	Platin gebürstet	36 210 740-06
	Light Gold	36 210 740-26
	Messing gebürstet (23kt Gold)	36 210 740-28
	Schwarz matt	36 210 740-33
	Bronze gebürstet	36 210 740-42
	Champagne gebürstet (22kt Gold)	36 210 740-46
	Champagne (22kt Gold)	36 210 740-47
	Dark Platinum gebürstet	36 210 740-99

Benötigtes Zubehör



- UP-Dreiwege-Umstellung -** 35 203 970 90
- Min. Einbautiefe 95 mm
 - Max. Einbautiefe 116 mm

36 210 740

mm [inches]

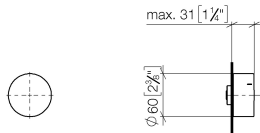

Durchflussdiagramm



Zertifikate

LGA_38380.

WRAS_2307045.

36 210 740

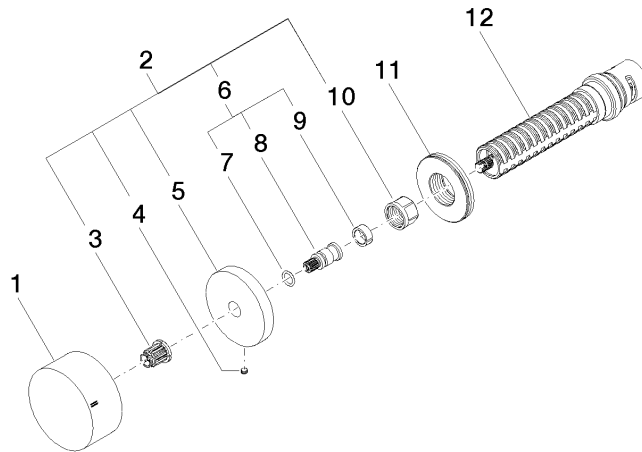

Ersatzteilstückliste

Nr.	Artikelnummer	Benennung	Verbaumenge	Lieferzeit
1	09 20 74 045-27	Griff	1	60
2	04 27 74 004 00-27	Rosette	1	60
3	90 12 12 002 00 90	Rastbuchse	1	2
4	09 31 11 055 90	Stift	1	2
5	09 27 74 004-27	Rosette	1	60
6	04 29 06 020 00-00	Spindel	1	10
7	90 14 10 060 00 90	Dichtung	1	2
8	09 29 06 020-27	Spindel	1	-
Ersatzteil nicht mehr bestellbar, bitte bestellen Sie den Nachfolgeartikel				
9	90 14 15 020 03 90	Ring	1	2
10	90 23 30 023 00 90	Mutter	1	2
11	09 30 01 107 90	Huelse	1	2
12	90 90 03 303 10 90	Umstellung	1	2