















36 503 979



- Abdeckplatte Ø 124 mm
- Skalengriff mit Sicherheitssperre bei 38°C
- Thermostat-Kartusche

	Champagne (22kt Gold)	36 503 979-47
	Chrom	36 503 979-00
	Platin gebürstet	36 503 979-06
	Platin	36 503 979-08
	Messing (23kt Gold)	36 503 979-09
	Dark Chrome	36 503 979-19
	Light Gold	36 503 979-26
	Light Gold gebürstet	36 503 979-27
	Messing gebürstet (23kt Gold)	36 503 979-28
	Schwarz matt	36 503 979-33
	Bronze gebürstet	36 503 979-42
	Champagne gebürstet (22kt Gold)	36 503 979-46
	Chrom gebürstet	36 503 979-93
	Dark Platin gebürstet	36 503 979-99

Benötigtes Zubehör



xTOOL UP-Thermostatmodul ohne Mengenregulierung - 35 503 970 90
 •Max. Einbautiefe 110 mm
 •Min. Einbautiefe 85 mm

Benötigtes Zubehör



xGRID Montageschiene 555 mm - 12 360 970 90

Empfohlenes Zubehör



xGRID Befestigungssatz für die Integration in den Trockenbau - 12 340 970 90

36 503 979

mm [inches]

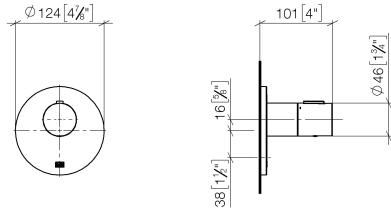

Durchflussdiagramm

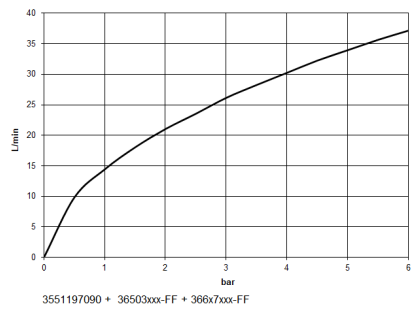

Zertifikate

WRAS_2011026.

DVGW_DW-
6512DN0706.

LGA_29930.

36 503 979

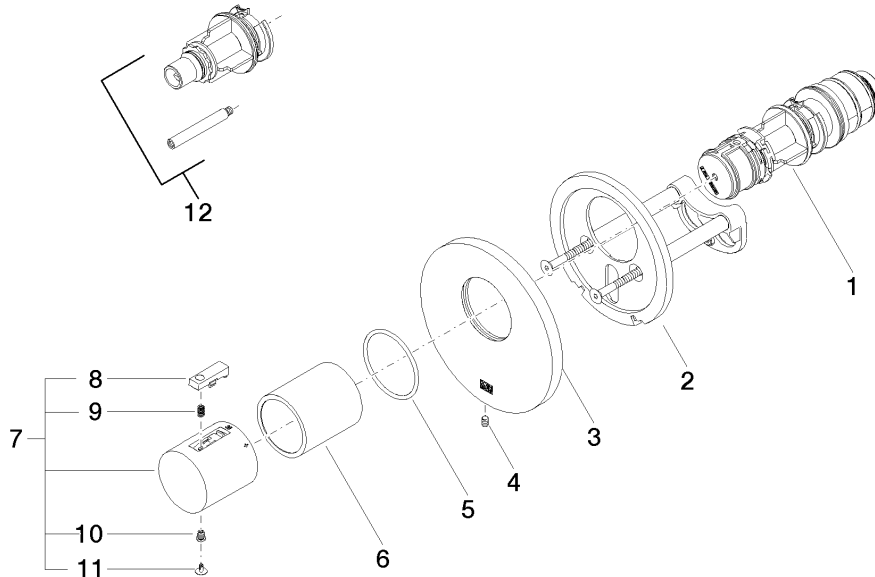

Ersatzteilstückliste

Nr.	Artikelnummer	Benennung	Verbaumenge	Lieferzeit
1	90 15 02 063 00 90	Kartusche	1	2
2	90 11 01 196 00 90	Aufnahme	1	2
3	09 11 02 537-47	Abdeckung	1	30
4	09 31 11 048 90	Stift	1	2
5	90 14 10 049 00 90	Dichtung	1	2
6	90 21 02 112 00-47	Huelse	1	30
7	90 17 33 004 00-47	Griff	1	30
8	90 21 33 011 00-13	Griff	1	2
9	90 16 02 027 00 90	Feder	1	2
10	90 30 30 136 00 90	Schraube	1	2
11	90 31 20 049 00-13	Stopfen	1	30
12	12 178 970 90	Verlängerung 46 mm -	1	2