













36 512 979



- druckvoller Flachstrahl
- horizontaler Strahl
- Abdeckplatte 240 x 60 mm
- Strahl verstellbar
- Anschluss 1/2"
- Durchfluss max. 10 l/min
- Dieses Produkt leistet einen Beitrag zur Erfüllung der Vorgaben von nachhaltigen Gebäudezertifizierungen, z.B. LEED®, BREEAM®, DGNB

Passt zu: IMO, LULU, MADISON, MEM, TARA, CL.1, LISSÉ, VAIA, META, CYO

	Messing gebürstet (23kt Gold)	36 512 979-28
	Chrom	36 512 979-00
	Platin gebürstet	36 512 979-06
	Platin	36 512 979-08
	Dark Chrome	36 512 979-19
	Light Gold	36 512 979-26
	Light Gold gebürstet	36 512 979-27
	Schwarz matt	36 512 979-33
	Bronze gebürstet	36 512 979-42
	Champagne gebürstet (22kt Gold)	36 512 979-46
	Champagne (22kt Gold)	36 512 979-47
	Chrom gebürstet	36 512 979-93
	Dark Platin gebürstet	36 512 979-99

Benötigtes Zubehör

	UP-Wandeinbaukasten - •Max. Einbautiefe 173 mm •Min. Einbautiefe 100 mm	35 206 970 90
---	--	---------------

Empfohlenes Zubehör

	xGRID Befestigungssatz für die Integration in den Trockenbau -	12 340 970 90
---	---	---------------

Benötigtes Zubehör

	xGRID Montageschiene 555 mm -	12 360 970 90
---	--------------------------------------	---------------

36 512 979

mm [inches]

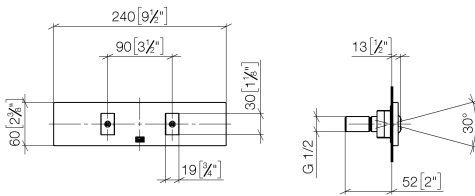

Durchflussdiagramm



Wurfweitendiagramm

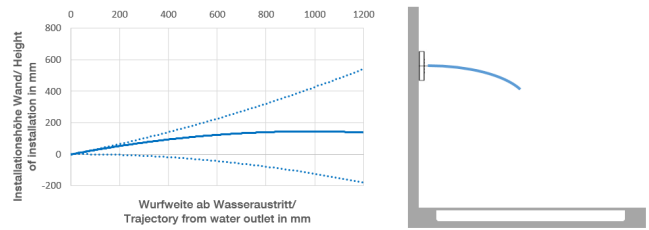

Zertifikate

LGA_29335.

WRAS_2005003.

36 512 979

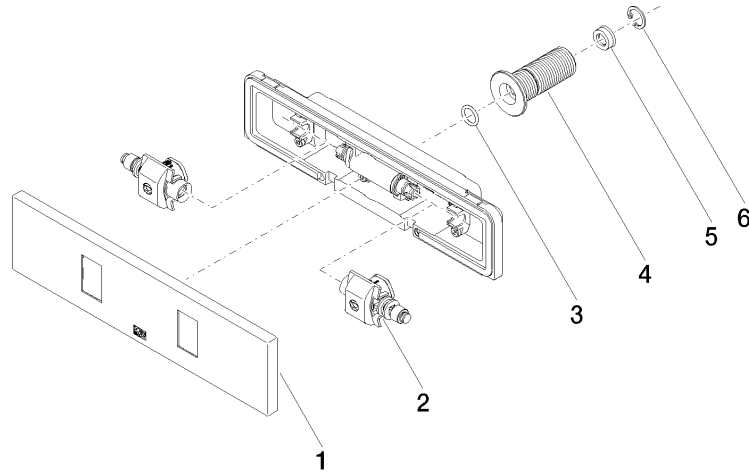

Ersatzteilstückliste

Nr.	Artikelnummer	Benennung	Verbaumenge	Lieferzeit
1	90 27 99 002 00-28	Einsatz	1	20
2	90 31 10 012 00 90	Einsatz	1	2
3	09 14 10 003 90	Dichtung	1	2
4	09 24 05 015 90	Nippel	1	2
5	09 23 01 134 90	Durchflussbegrenzer	1	2
6	09 16 01 014 90	Ring	1	2