









36 607 742



- ohne Rosette
- Griff Ø 60 mm
- mit Warmkennzeichnung
- Oberteil mit ablängbarer Spindel und Hülse

Passt zu: CL.1, CYO

	Dark Chrome	36 607 742-19
	Chrom	36 607 742-00
	Platin gebürstet	36 607 742-06
	Messing gebürstet (23kt Gold)	36 607 742-28
	Schwarz matt	36 607 742-33
	Champagne gebürstet (22kt Gold)	36 607 742-46
	Champagne (22kt Gold)	36 607 742-47
	Dark Platinum gebürstet	36 607 742-99

36 607 742

mm [inches]

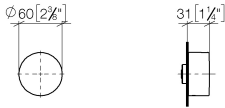

Zertifikate

LGA_38107.

LGA_29931.

WRAS_2010066.

36 607 742

Ersatzteile für die
anderen
Oberflächenvarianten
finden Sie hier:
Chrom

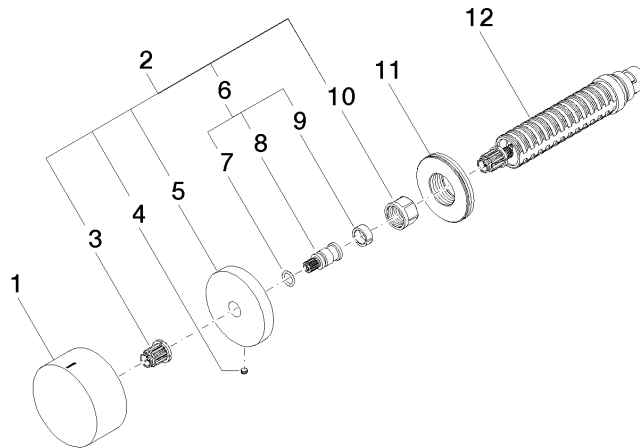

Ersatzteilstückliste

Nr.	Artikelnummer	Benennung	Verbaumenge	Lieferzeit
1	09 20 74 021-19	Griff (hot)	1	60
2	04 27 74 004 00-19	Rosette	1	20
3	90 12 12 002 00 90	Rastbuchse	1	2
4	09 31 11 055 90	Stift	1	2
5	09 27 74 004-19	Rosette	1	20
6	04 29 06 020 00-00	Spindel	1	10
7	90 14 10 060 00 90	Dichtung	1	2
8	09 29 06 020-19	Spindel	1	-
Ersatzteil nicht mehr bestellbar, bitte bestellen Sie den Nachfolgeartikel				
9	90 14 15 020 03 90	Ring	1	2
10	90 23 30 023 00 90	Mutter	1	2
11	09 30 01 107 90	Huelse	1	2
12	90 90 03 142 00 90	Oberteil	1	2