















83 281 530

- Breite 150 mm
- Höhe 40 mm
- Ausladung 165 mm



Passt zu: IMO, LULU, MADISON, MEM, TARA, CL.1, LISSÉ, VAIA, META, CYO

|   |                                 |               |
|---|---------------------------------|---------------|
|    | Light Gold gebürstet            | 83 281 530-27 |
|    | Chrom                           | 83 281 530-00 |
|    | Platin gebürstet                | 83 281 530-06 |
|    | Platin                          | 83 281 530-08 |
|    | Messing (23kt Gold)             | 83 281 530-09 |
|    | Dark Chrome                     | 83 281 530-19 |
|    | Light Gold                      | 83 281 530-26 |
|    | Messing gebürstet (23kt Gold)   | 83 281 530-28 |
|    | Schwarz matt                    | 83 281 530-33 |
|   | Bronze gebürstet                | 83 281 530-42 |
|  | Champagne gebürstet (22kt Gold) | 83 281 530-46 |
|  | Champagne (22kt Gold)           | 83 281 530-47 |
|  | Chrom gebürstet                 | 83 281 530-93 |
|  | Dark Platinum gebürstet         | 83 281 530-99 |

83 281 530

mm [inches]



83 281 530

Ersatzteile für die  
anderen  
Oberflächenvarianten  
finden Sie hier:  
Chrom

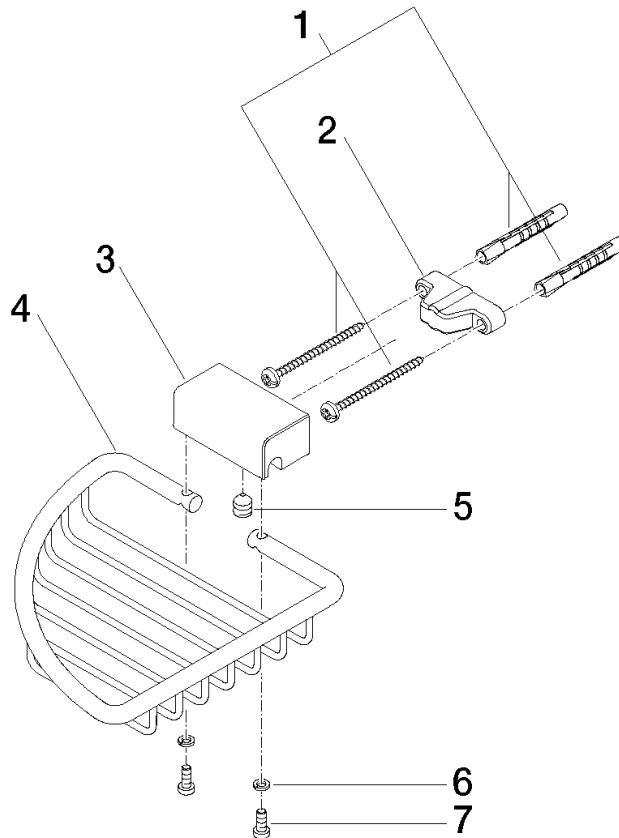

### Ersatzteilstückliste

| Nr. | Artikelnummer      | Benennung        | Verbaumenge | Lieferzeit |
|-----|--------------------|------------------|-------------|------------|
| 1   | 05 30 31 025 00 90 | Befestigungssatz | 1           | 2          |
| 2   | 09 17 20 030 90    | Halter           | 1           | 2          |
| 3   | 08 17 30 501-27    | Halter           | 1           | 60         |
| 4   | 08 18 90 905-27    | Korb             | 1           | 60         |
| 5   | 09 31 11 002 90    | Stift            | 1           | 2          |
| 6   | 90 30 11 029 00 90 | Scheibe          | 2           | 2          |
| 7   | 09 30 30 054 90    | Schraube         | 2           | 2          |